

Color-graying vision sensor

F400

Detects subtle color differences

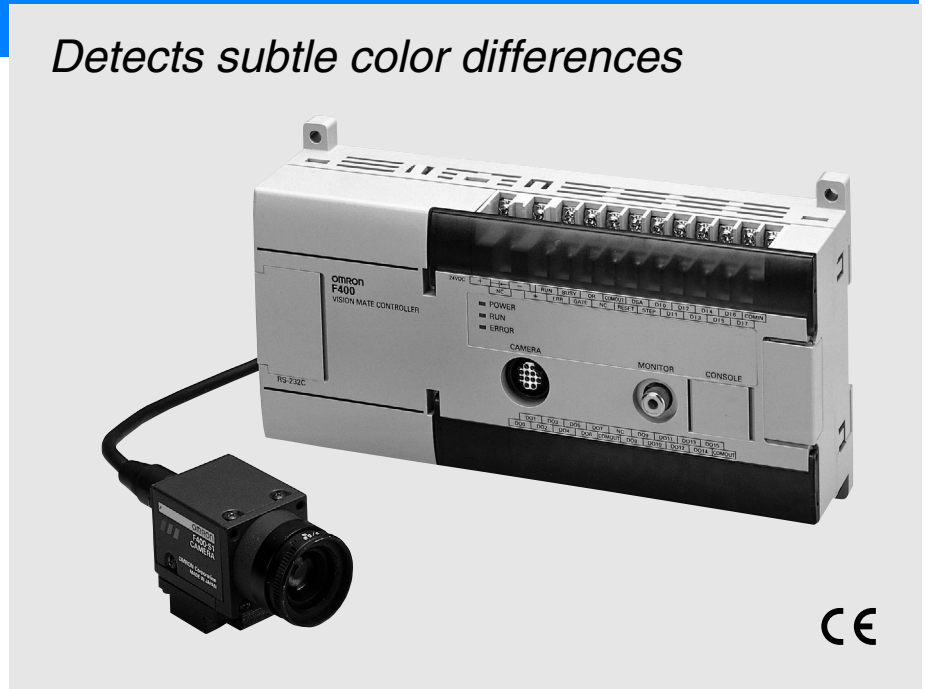

F400

Features

In addition to regular color extraction, the F400 color-graying sensor features the world's first color-graying filter. This is a completely new type of sensor that enables easy and inexpensive detection of subtle color differences that could not be discriminated by monochrome processing or color extraction.



Includes a color-grayed filter

① Good discrimination of subtle color differences (example: inspection for cap damage)



Original image



Color-grayed image
Defects barely visible in the original image stand out clearly.

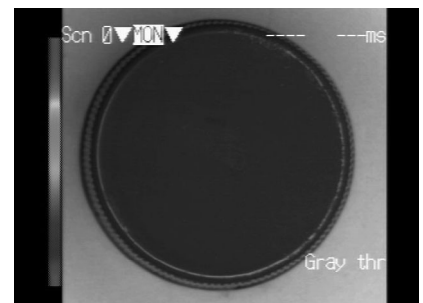

Monochrome image
The defects are barely visible.

Features

② Handles lighting changes well. (Example: inspection of colored pencil arrangement when the color is set to red)

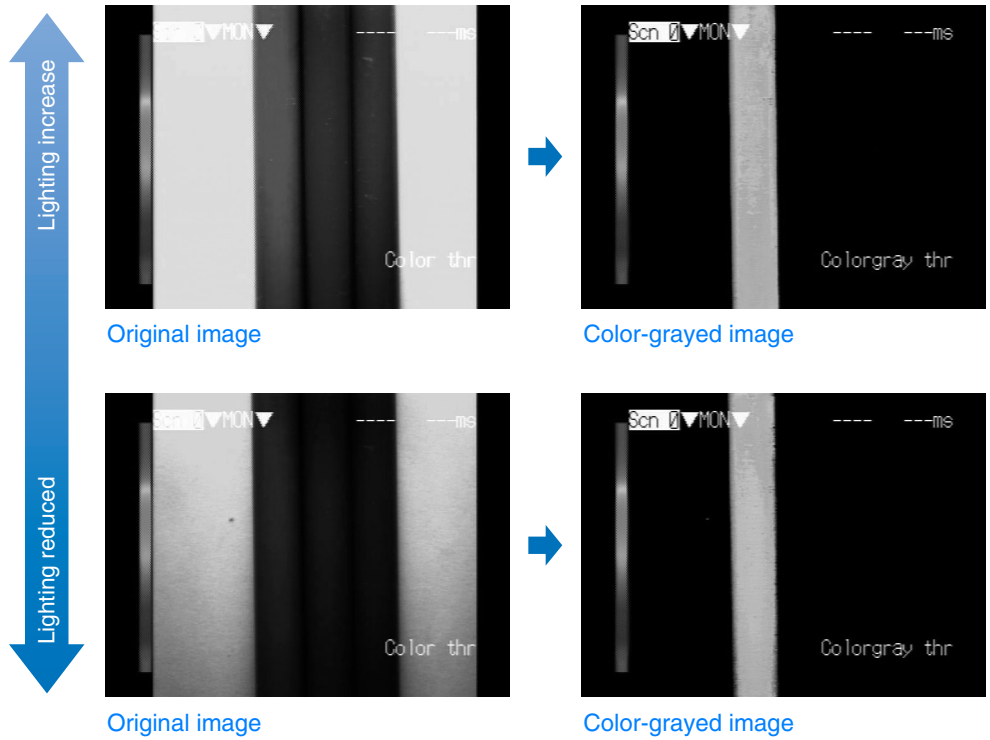

Even if the illumination is darkened, a stable color-grayed image can be obtained.

Ease-of-Use

① The character color displayed on the screen can be changed.

Select the character color that is easiest to see based on the color of the work.

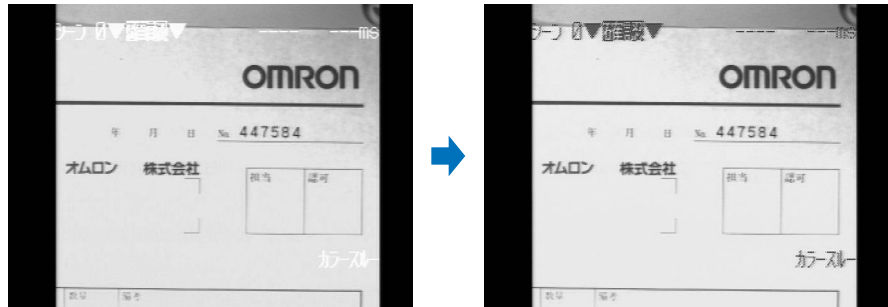

White characters on a white background are difficult to see.

Change the character display to red.

② Enhanced measurement area drawing function.

The optimum measurement area can be selected for complex work shapes.

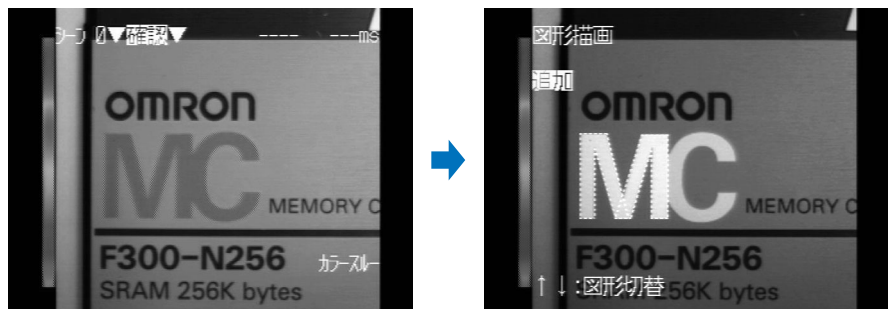

Measure an orange "M".

Draw an area outlining the character

Features

Other functions

RGB filters

In addition to the color-graying filter, the sensor is equipped with R (red), G (green), and B (blue) filters.

- Use the filter most suitable to the color of the object and the purpose of the inspection.

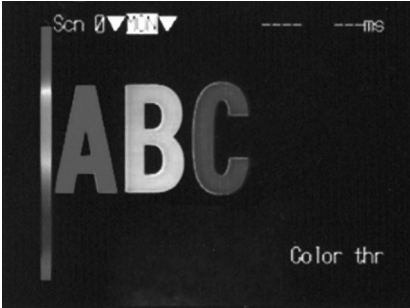

Color image (original image)

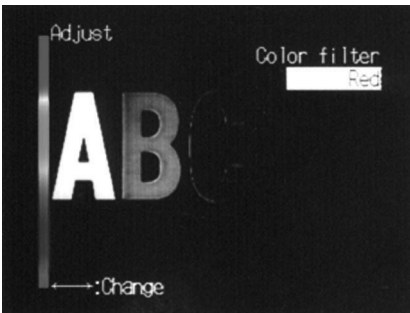

R (red) filter image

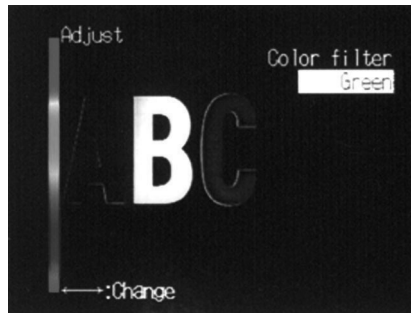

G (green) filter image

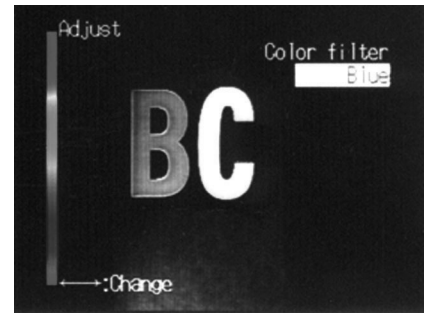

B (blue) filter image

Color extraction function

Up to 8 colors can be simultaneously detected for viewing, and the area, center of gravity, and position deviation can be measured at high speed and high precision.

- Ideal for color sorting, color discrimination, foreign object checking, and a color arrangement check.

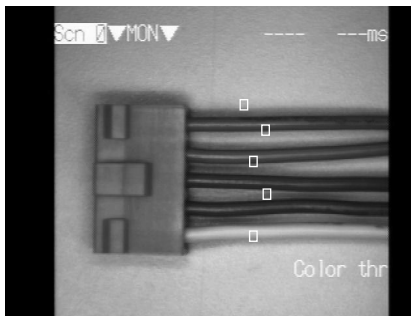

Original image

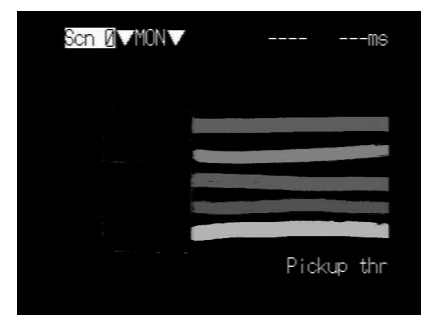

Color-extracted image

Multi-type measurement mode

The highly-acclaimed multi-type measurement algorithm in F150-2 has also been included.

- Binary measurement / dark-light measurement algorithm
- Damage and dirt measurement / edge position measurement algorithm
- "No good" image storage (filter-processed monochrome images)

*The actual device image may differ from the catalog photograph.

F400

Application

Color-graying processing

Cap dirt inspection

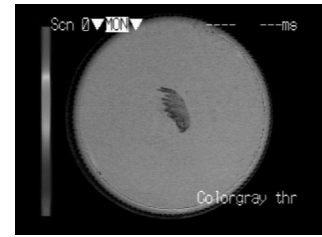
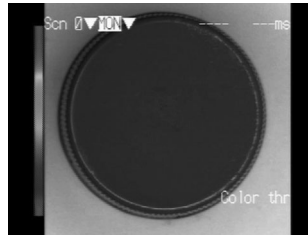
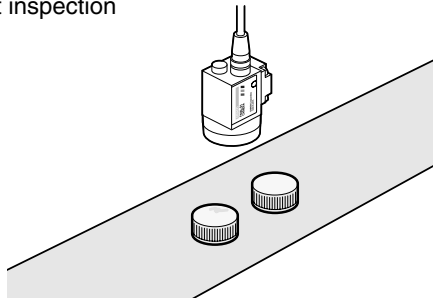

Original image

Filtered image

The contrast between the cap color and dirt can be increased.

Presence inspection of mustard for beans

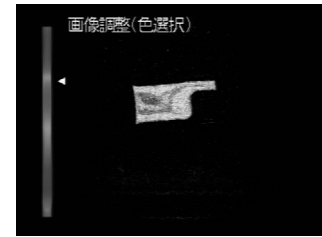
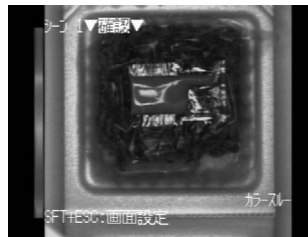
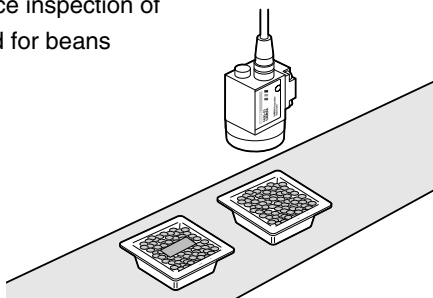

Original image

Filtered image

Presence inspection is possible regardless of the position of the mustard for the beans.

Adhesive coating inspection

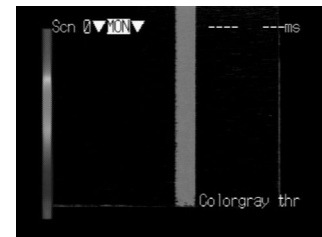
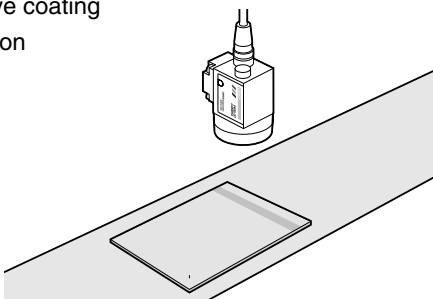

Original image

Filtered image

Using the edge detection function to inspect the quantity (width) of adhesive coating on a copper plate.

Color extraction processing

Paper cup color discrimination

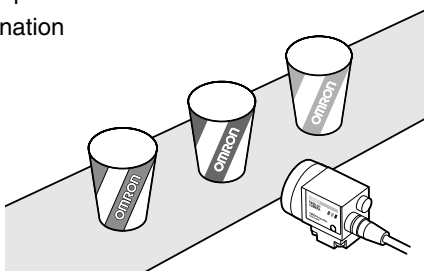

Original image

Color-extracted image

Checking wire harness color arrangement

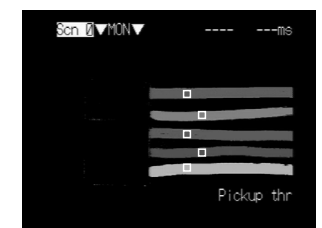
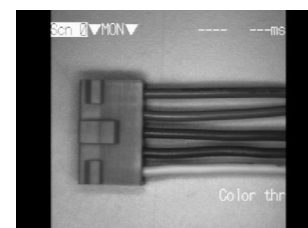
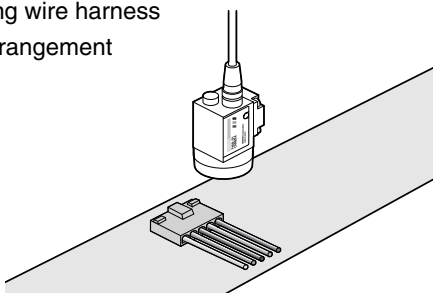

Original image

Color-extracted image

*The actual device image may differ from the catalog photograph.

System configuration

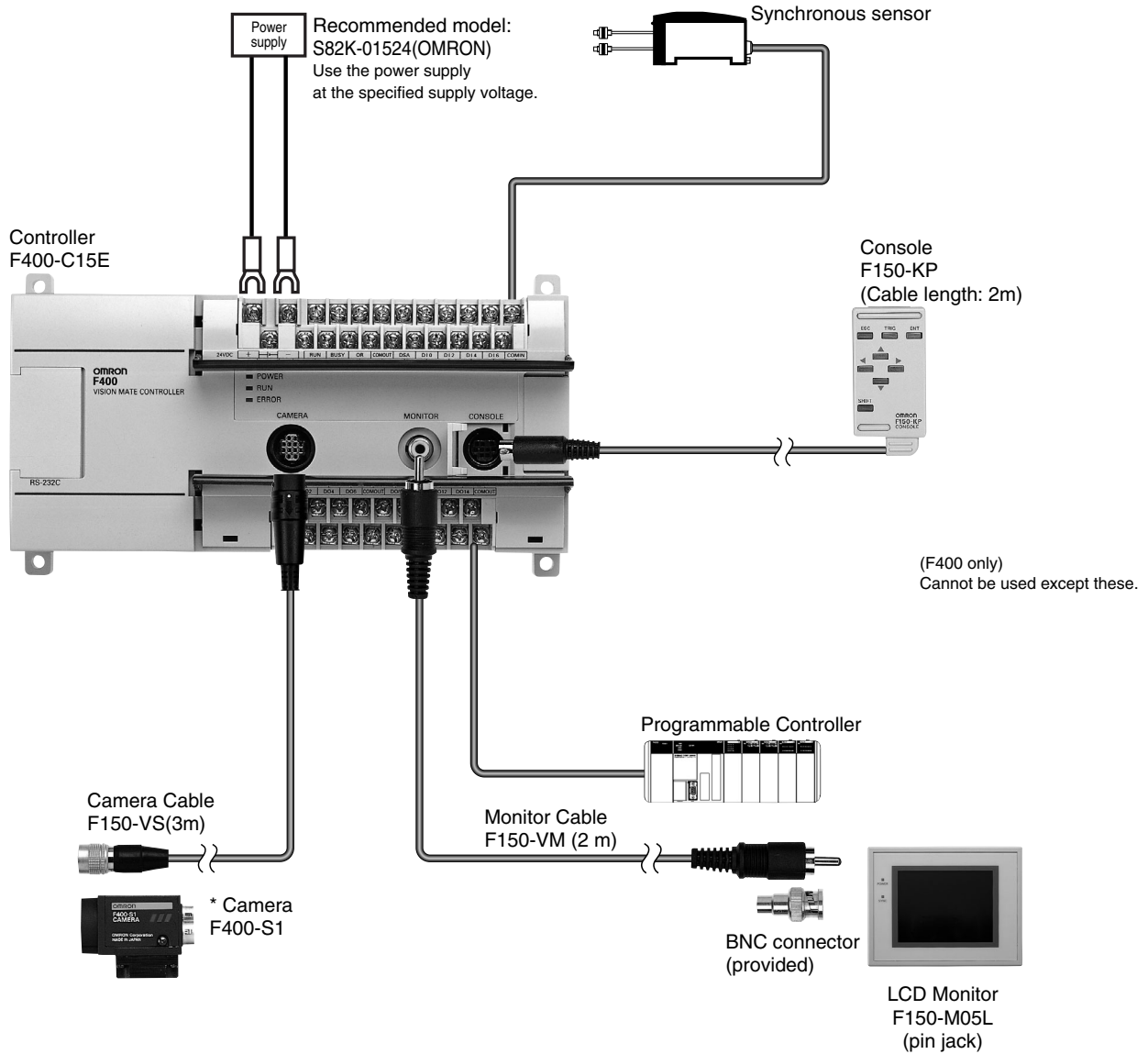

Note: Please refer to *Lens Details (C-94)* about selection of a lens.

Ordering Information

Name	Model
Controller	F400-C15E
Camera	F400-S1
Console	F150-KP
LCD monitor	F150-M05L
Camera cable	F150-VS
Monitor cable	F150-VM
Lens	For details, see option
Lighting	

Rating/Performance

Controller/F400-C15E

Item	Model	F400-C15-E	
Item	Item	Color extraction	Color-graying / color filter (R G B)
Number of connected cameras	1 unit		
Processing resolution	512(H) x 484(V)		
Number of scenes	16 scenes		
Image memory function	Up to 16 scenes can be stored (only filter-processed monochrome images)		
Operation	Color extraction / selection by color filter		
Processing method	Color extraction: Up to 8 colors	256-shade image (select by color group: gray, red, green, blue)	
Image pre-processing	---	Smoothing, edge enhancement, edge extraction, background cut-off	
Binary level	---	256 levels (per measurement area)	
Position correction function	Correction directions: X, Y, Inspection modes: binary center of gravity / main axis angle, search (1 model / 2 models), edge position (1 area / 2 areas)		
Number of measurement areas	16 areas/scene		
Measured data	Binary area, center of gravity, main axis angle, relative value, search position, edge position	Binary area, center of gravity, main axis angle, relative value, search position, edge position, damage/dirt (degree of defect)	
Calculation functions	Four arithmetic operations, distance, angle, square root, maximum, minimum		
Result output	Overall decision, computation result decision, by measurement area, measurement/computation data		
Monitor	1 ch (supports pin jack and over-scan monitor)		
RS-232C	1 ch (Dsub, 9 pins, female)		
Parallel input/output	Input: 11 points, output: 21 points (including control inputs/outputs)		
Power supply voltage	20.4 to 26.4 V DC, including ripple (p-p)		
Current consumption	0.6 A or less		
Ambient temperature	Operating: 0 to +50°C, storage: -25 to +65°C (no icing or condensation)		
Ambient humidity	Operating/Storage: 35% to 85% RH (with no condensation)		
Weight (Packed state)	Approximately 1.3 kg (unit: approximately 600 g)		
Accessories	Operation Manuals (3)		

Camera/F400-S1

Item	Model	F400-S1
Image pick-up		1/3 inch color CCD
Effective pixels		659(H) x 494(V)
Shutter function		Electronic shutter: 1/100 s, 1/500 s, 1/2000 s, 1/10000 s (changed by menu)
Lens mount		C mount
Ambient temperature		Operating: 0 to +50°C, storage: -25 to +65°C (no icing or condensation)
Ambient humidity		Operating/Storage: 35% to 85% RH (with no condensation)
Weight (Packed state)		Approximately 180 g (unit: approximately 80 g)
Accessories		Lens cap, 4-pin connector cover

LCD monitor

Item	Model	F150-M05L
Size		5.5 inch
Type		TFT color LCD
Resolution		320 x 240 dots
Input signal		NTSC composite video (1.0 V / 75)
Power supply voltage		20.4 to 26.4 VDC
Current consumption		Approx. 700 mA
Ambient temperature		Operating: 0 to +50°C, storage: -25 to +65°C (no ice formation or condensation)
Ambient humidity		Operating/Storage: 35% to 85% RH (with no condensation)
Weight * Unit only		Approx. 1 kg
Accessories		Operation manual, 4 clamps

Nomenclature:

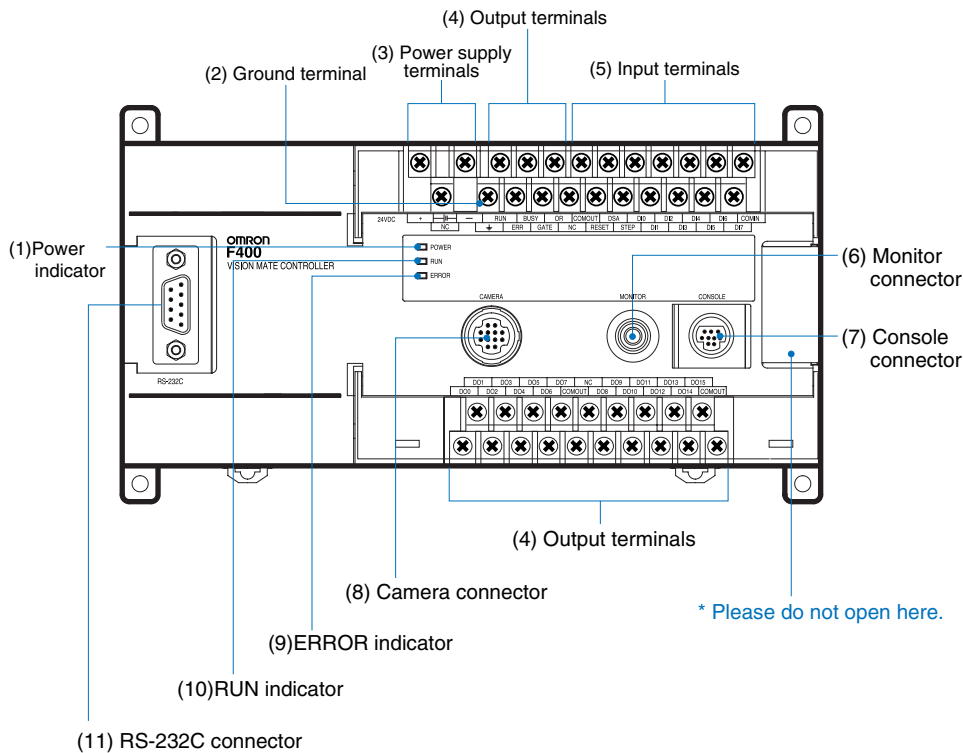

- (1) Lit while power is ON.
- (2) Connects to the ground wire.
- (3) Connects to the power supply.
- (4) Connects to the F400 to external devices such as synchronous sensors or programmable controllers.
- (5) Connects to the monitor.
- (6) Connects to the monitor.
- (7) Connects to the console.
- (8) Connects to the camera.
- (9) Lit when an error has occurred.
- (10) Lit while the F400 is in Run Mode.
- (11) Connects the F400 to external devices such as personal computers or programmable controllers.

F400

Function menu

Measurement method

Five measurement modes are available. Selections will vary depending on the selected scene mode.

Common to both color extraction and color filter mode.

Search

Select this mode when you wish to focus the inspection on the shape of the object. An image pattern (called a "model") is stored, and measurement is performed using that pattern. The degree of matching with the model (correlation value) and the position where the model was found can be obtained.

Edge

Select this mode when you wish to know the coordinates of the edge of the object. The width of the object can also be obtained by subtracting the coordinates of one edge from the other using a computation equation.

Area and center of gravity

Select this mode if you wish to obtain the size (called the "area") and the position (called the "center of gravity") of the object.

Center of gravity and main axis angle

Select this mode when you wish to obtain the tilt (called the "main axis angle") of the object, in addition to the area and position. A longer processing time is required to obtain the main axis angle. If you only wish to obtain the area and center of gravity, select "Center of gravity and main axis angle".

Color filter mode only

Dirt and damage

Select this mode if you wish to inspect for damage and dirt on the measurement object. Places with large darkness deviations are detected as defective.

Menu structure diagram

The menu structure differs in color extraction mode and color filter mode. The menu structure for each scene mode is as follows:

Color extraction mode

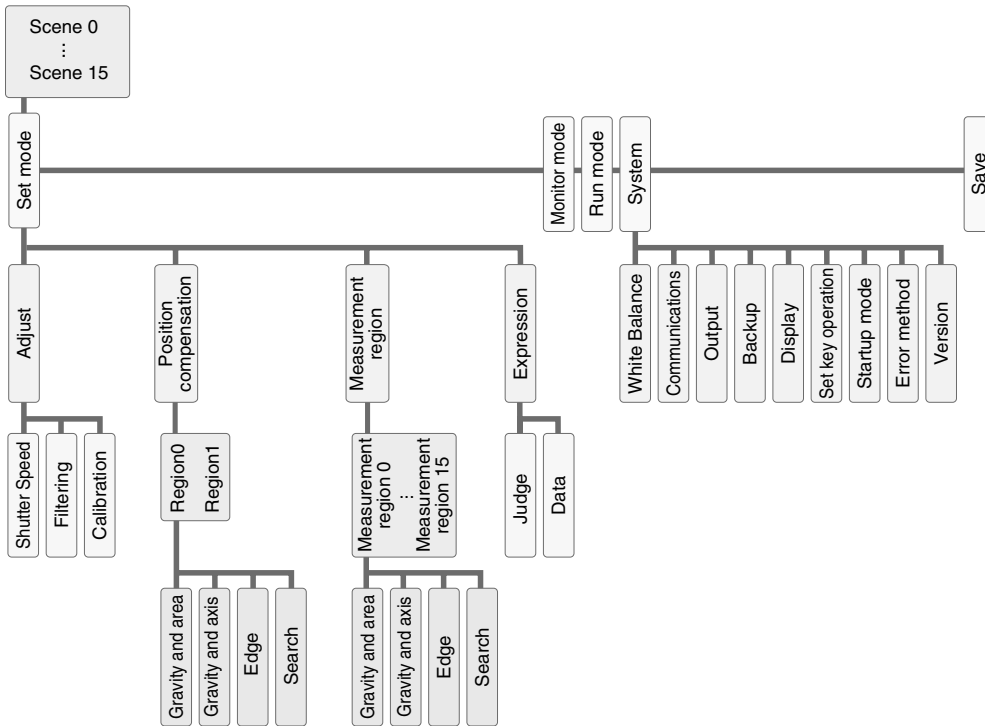

Color filter mode

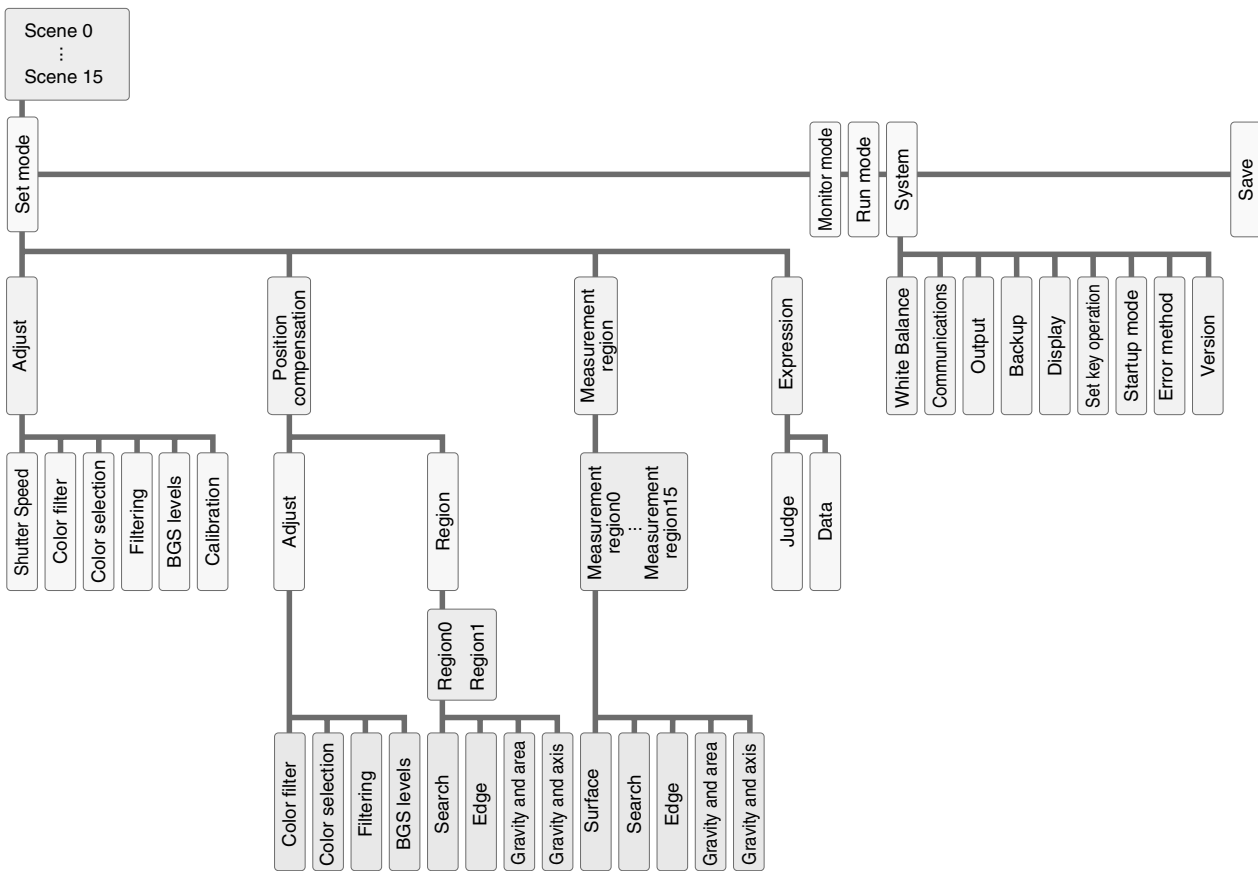

Dimensions (Unit: mm)

Controller
F400-C15E

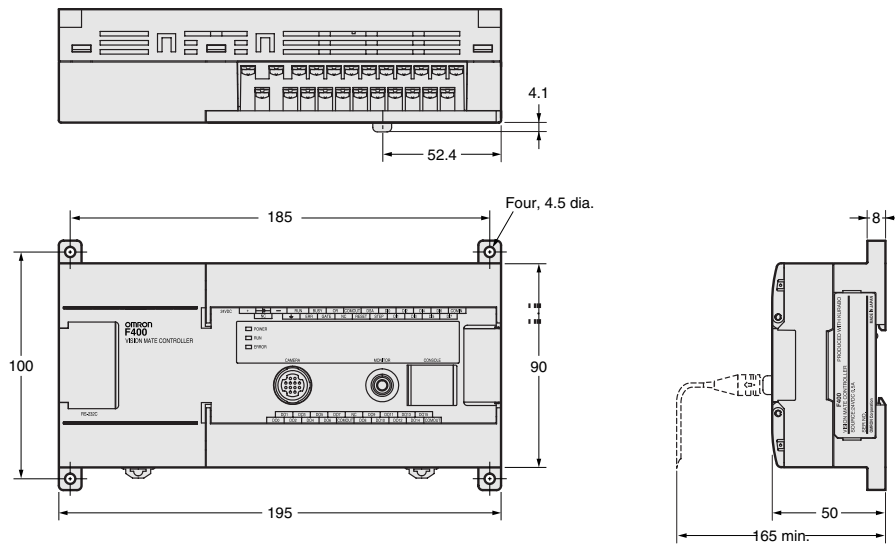

Camera
F400-S1

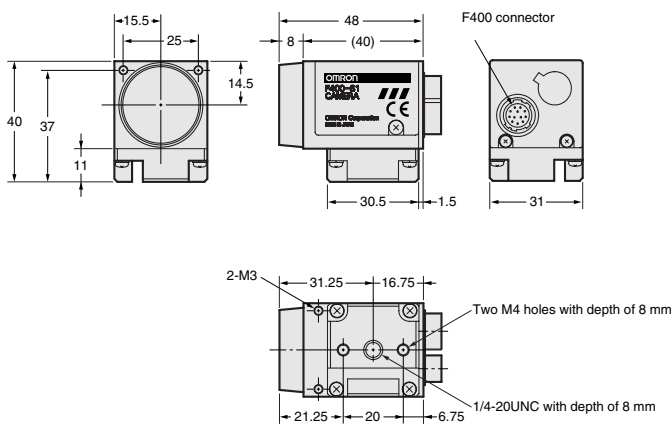

Console
F150-KP

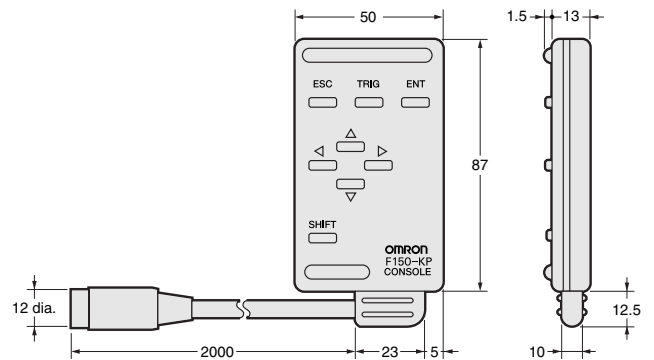

LCD monitor
F150-M05L

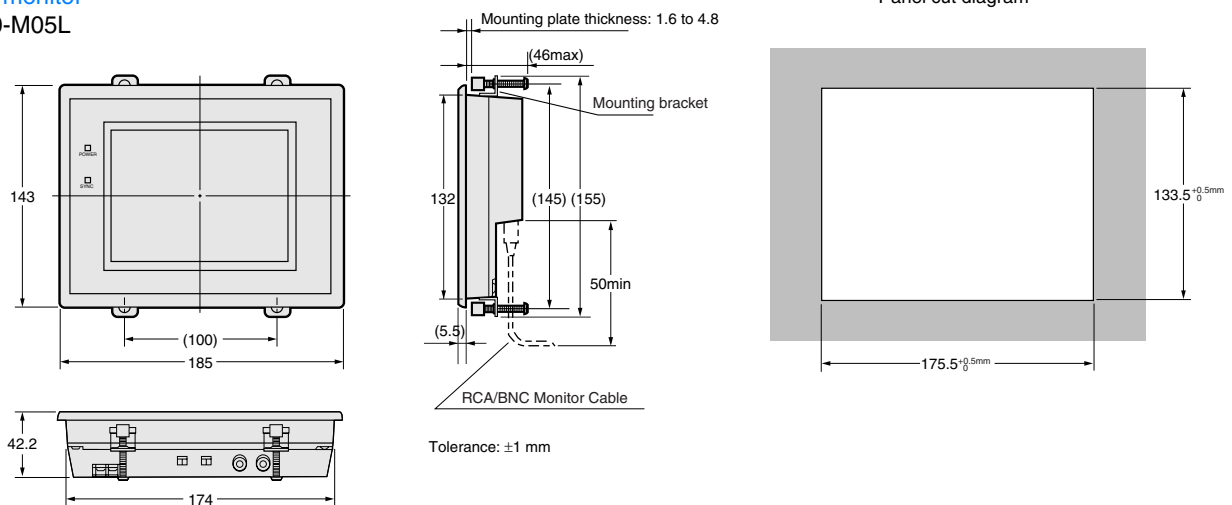

ALL DIMENSIONS SHOWN ARE IN MILLIMETERS.
To convert millimeters into inches, multiply by 0.03937. To convert grams into ounces, multiply by 0.03527.