

Photoelectric Sensors with Separate Digital Amplifiers (Laser-type Amplifier Units)

E3C-LDA Series

- All seven laser types provide ample long distance, for the Diffuse Reflective Model 1.000 mm and for Retroreflective Models up to 7.000 mm.
- Coaxial Retroreflective Models provide detection performance equivalent to through-beam sensors, simplifying Sensor installation.
- Industry-first variable focal point and optical axis alignment mechanisms. Optimize for workpieces and improve inspection quality.
- Drive the laser with an Amplifier the same size as a Digital Fiber Amplifier.



NEW CE

Ordering Information

Sensor Heads

Sensing method	Focus	Model number	Remarks
Diffuse reflective	Spot	E3C-LD11	Mounting a Beam Unit (sold separately) allows the use of line and area beams.
	Line	E3C-LD21	This model number is for the set consisting of the E39-P11 mounted to the E3C-LD11.
	Area	E3C-LD31	This model number is for the set consisting of the E39-P21 mounted to the E3C-LD11.
Coaxial retroreflective	Spot (variable)	E3C-LR11 (See note.)	Mounting a Beam Unit (sold separately) allows the use of line and area beams.
	Spot (2.0-mm fixed dia.)	E3C-LR12 (See note.)	---

Note: Select a reflector (sold separately) according to the application.

Amplifier Units

Amplifier Units with Cables

Item		Appearance	Functions	Model	
				NPN output	PNP output
Advanced models	Twin-output models		Area output, self-diagnosis, differential operation	E3C-LDA11	E3C-LDA41
	External-input models		Remote setting, counter, differential operation	E3C-LDA21	E3C-LDA51

Amplifier Units with Connectors



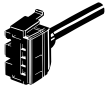
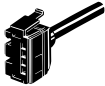

Item		Appearance	Functions	Model	
				NPN output	PNP output
Advanced models	Twin-output models		Area output, self-diagnosis, differential operation	E3C-LDA6	E3C-LDA8
	External-input models		Remote setting, counter, differential operation	E3C-LDA7	E3C-LDA9

Amplifier Unit Connectors (Order Separately)

Item	Appearance	Cable length	No. of conductors	Model
Master Connector		2 m	4	E3X-CN21
Slave Connector			2	E3X-CN22



Note: Use the E3X-MC11-S Mobile Console for the E3C-LDA series Amplifier Units. Other Mobile Consoles cannot be used.

Mobile Console (Order Separately)





Appearance	Model	Remarks
	E3X-MC11-SV2-EU E3X-MC11-SV2-UK (model number of set)	Mobile Console with Head, Cable, and AC adapter provided as accessories
	E3X-MC11-C1-SV2	Mobile Console
	E3X-MC11-H1	Head
	E39-Z12-1	Cable (1.5 m)

Accessories (Order Separately)

Beam Units

Applicable Sensor Head	Appearance	Focus	Model
E3C-LD11		Line	E39-P11
		Area	E39-P21
E3C-LR11		Line	E39-P31
		Area	E39-P41

Reflectors

Type	Appearance	Model
Standard Effective area: 23 × 23 mm		E39-R12
Standard Effective area: 7 × 7 mm		E39-R13
Transparent detection Effective area: 23 × 23 mm		E39-R14
Sheet (cuttable) Effective area: 195 × 22 mm		E39-RS4
Sheet (cuttable) Effective area: 108 × 46 mm		E39-RS5

Specifications

Ratings/Characteristics

Sensor Heads

Item	Diffuse reflective			Coaxial retroreflective			
	E3C-LD11	E3C-LD21	E3C-LD31	E3C-LR11	E3C-LR11 + E39-P31	E3C-LR11 + E39-P41	E3C-LR12
Light source (emission wavelength)	Red semiconductor laser diode (650 nm), 2.5 mW max. (JIS standard: Class 2, FDA standard: Class II)						1 mW max. (JIS standard Class 1)
Sensing distance	High-resolution mode: 30 to 1,000 mm Standard mode: 30 to 700 mm Super-high-speed mode: 30 to 250 mm (See note 1.)			7 m 5 m 2 m (See note 2.)	1,700 mm, 1,300 mm 700 mm (See note 2.)	900 mm 700 mm 400 mm (See note 2.)	7 m 5 m 2 m (See note 2.)
Beam size (See note 3.)	0.8 mm max. (at distances up to 300 mm)	33 mm (at 150 mm)	33 × 15 mm (at 150 mm)	0.8 mm max. (at distances up to 1,000 mm)	28 mm (at 150 mm)	28 × 16 mm (at 150 mm)	2.0 mm dia. (at distances up to 1,000 mm)
Functions	Variable focal point mechanism (beam size adjustment) (See note 4.), optical axis adjustment mechanism (axis adjustment)						
Indicators	LDON indicator: Green; Operation indicator: Orange						
Ambient illumination (receiver side)	3,000 lx (incandescent lamp)						
Ambient temperature	Operating: -10°C to 55°C; Storage: -25°C to 70°C (with no icing or condensation)						
Ambient humidity	Operating/storage: 35% to 85% (with no condensation)						
Vibration resistance (destruction)	10 to 150 Hz with double amplitude of 0.7 mm, in X, Y, and Z directions for 80 min each						
Degree of protection	IEC 60529: IP40						
Materials	Case and cover: ABS Front surface filter: Acrylic resin			Case and cover: ABS Front surface filter: Glass			
Weight (packed)	Approx. 85 g			Approx. 100 g			

Note 1. Values are sensed for white paper.

- These values apply when a E39-R12 Reflector is used. The MSR function is built-in. The reflected light from the object being measured may affect the sensing accuracy, so adjust the threshold value before use.
- The beam radius is the value for the middle measurement distance and indicates a typical value for the middle sensing distance. The radius is defined by light intensity of $1/e^2$ (13.5%) of the central light intensity.
Light will extend beyond the main beam and may be affected by conditions surrounding the object being measured.
- The E3C-LR12 has a fixed beam size (the focus point cannot be changed).

Amplifier Units

Item	Model	Type	Advanced, twin-output models		Advanced, external-input models	
		NPN output	E3C-LDA11	E3C-LDA6	E3C-LDA21	E3C-LDA7
		PNP output	E3C-LDA41	E3C-LDA8	E3C-LDA51	E3C-LDA9
Supply voltage		12 to 24 VDC ±10%, ripple (p-p) 10% max.				
Power consumption		1,080 mW max. (current consumption: 45 mA max. at power supply voltage of 24 VDC)				
Control output		Load power supply voltage: 26.4 VDC max.; NPN/PNP (depends on model) open collector Load current: 50 mA max.; residual voltage: 1 V max.				
Response time	Super-high-speed mode	100 µs for operation and reset		80 µs for operation and reset		
	Standard mode	1 ms for operation and reset				
	High-resolution mode	4 ms for operation and reset				
Functions		Power tuning, differential detection, timer, zero-reset, initial reset, mutual interference prevention (See note 1.), preset counter (See note 2.), reversed display				
	I/O settings	Output setting (Select from channel 2 output, area output, or self-diagnosis.)		External input setting (Select from teaching, power tuning, zero reset, light OFF, or counter reset.)		
Display		Operation indicator for channel 1 (orange), operation indicator for channel 2 (orange)		Operation indicator (orange), Power Tuning indicator (orange)		
Digital display		Select from the following: Incident level + threshold, incident level percentage + threshold, incident light peak level + no incident light bottom level, minimum incident light peak level + maximum no incident light bottom level, long bar display, incident level + peak hold, incident level + channel		Select from same displays as given at the left or a counter display.		
Ambient illumination (receiver side)		Incandescent lamp: 10,000 lux max. Sunlight: 20,000 lux max.				
Ambient temperature		Operating: Groups of 1 to 2 Amplifiers: -25°C to 55°C Groups of 3 to 11 Amplifiers: -25°C to 50°C Groups of 12 to 16 Amplifiers: -25°C to 45°C (with no icing or condensation) Storage: -30°C to 70°C (with no icing or condensation)				
Ambient humidity		Operating and storage: 35% to 85% (with no condensation)				
Connection method		Prewired cable	Separate connector	Prewired cable	Separate connector	
Weight (packed state)		Approx. 100 g	Approx. 55 g	Approx. 100 g	Approx. 55 g	
Materials	Case	Polybutylene terephthalate (PBT)				
	Cover	Polycarbonate				

*1: Communications are disabled if super-high-speed mode is selected, and the mutual interference prevention function and the communications function for the Mobile Console will not function.

*2: The preset counter is available only with advanced, external-input models.

Nomenclature

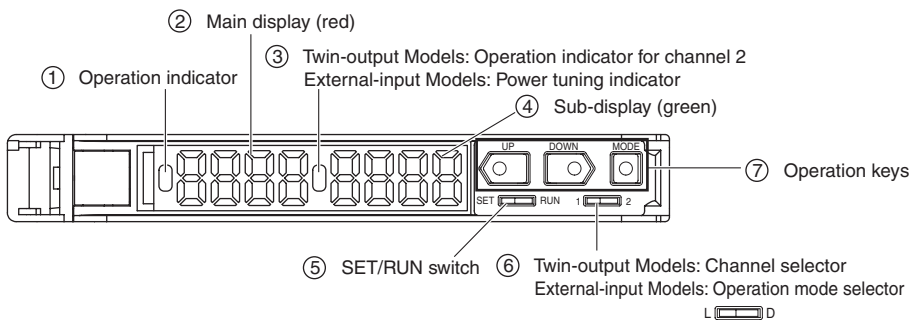

- ① Lit when the output is ON.
Twin-output Models: Lit when the output for channel 1 is ON.
- ② Displays the incident light level or the function name.
- ③ Twin-output Models: Lit when the output for channel 2 is ON.
External-input Models: Lit when power tuning is set.
- ④ Displays supplemental detection information, the setting of a function, etc.
- ⑤ Used to switch the mode.
- ⑥ Twin-output Models: Used to select the channel to display or set.
External-input Models: Used to select dark-ON or light-ON operation
- ⑦ Used to change the display, set functions, etc.

Basic Operating Information



Setting the Mode

The mode is set using the SET/RUN switch. Set this switch according to the operation to be performed.

Mode	Description
SET	Select to set detection conditions, to teach the threshold value, etc.
RUN	Select for actual detection operation or to set the following: Manual adjustment of thresholds, power adjustment, zero reset, or key lock.

Key Operations

The operation keys are used to switch the displays and set detection conditions. The functions of the keys depend on the current mode.

Key	Function	
	RUN mode	SET mode
UP key 	Increases the threshold.	Depends on the setting. –Executes teaching. –Changes the setting forward.
DOWN key 	Decreases the threshold.	Depends on the setting. –Executes teaching. –Changes the setting in reverse.
MODE key 	Depends on the MODE key setting. –Executes power tuning (default setting). –Executes a zero reset.	Switches the function to be set on the display.



Time to Press Keys

If a specific time for pressing a key is not given in a procedure, press the key for approximately 1 second. For example, if the procedure says “press the UP key,” then press the UP key for approximately 1 second and then release it.

Reading Displays

The information displayed on the main display and sub-display depends on the current mode.

For the default settings, the RUN mode displays will appear when the power supply is turned ON for the first time

Mode	Main display (red)	Sub-display (green)
Set	Displays the incident light level,* function name, or other information depending on the key operation. *The incident light level will be displayed even if DIFF (differential operation) is set for the detection method.	Displays threshold value* or the setting of the function displayed on the main display depending on the key operation. *The threshold value for the change in the incident light level will be displayed if DIFF (differential operation) is set for the detection method.
RUN (See note.)	For the default setting, the current incident light level will be displayed. The change in the incident light level will be displayed when DIFF (differential operation) is set for the detection mode.	For the default setting, the current threshold value will be displayed. The threshold value for the change in the incident light level will be displayed if DIFF (differential operation) is set for the detection method.

Note: The information that appears on the displays can be set using the display switch function. Refer to Detailed Settings.

Basic Settings

Setting the Operation Mode

Select either light-ON or dark-ON operation.

Selection	Description
LON (light-ON) (default)	The output will turn ON when the incident light level is above the threshold. If DIFF (differential operation) is set for the detection method, the output will turn ON when an edge is detected.
DON (dark-ON)	The output will turn ON when the incident light level is below the threshold. If DIFF (differential operation) is set for the detection method, the output will turn OFF when an edge is detected.

The setting method depends on the type of Amplifier Unit.

Type	Setting method
Twin-output model	Set as the operation mode in SET mode. Refer to 5. Detailed Settings.
External-input model 	Set using the operation mode selector.

Adjusting the Power (as Required)

Power tuning can be used to adjust the incident light level that is currently being received to the power tuning target value (default: 2,000). Before tuning ON the power, always secure the detection object and Head and be sure that the incident light level is stable.



The power tuning target value can be changed. Refer to Detailed Settings.



The incident light level may change when the detection method is changed. If necessary, retune the power after changing the detection method.

Setting Method

Confirm that the MODE key setting is PTUN (power tuning) in advance. PTUN is the default setting. Refer to Detailed Settings.

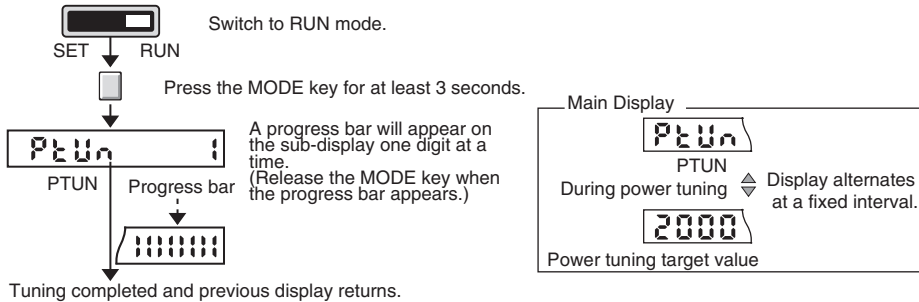

Setting Errors

An error has occurred if one of the following displays appears after the progress bar is displayed.

<p>Flashes twice PtUn over PTUN OVER</p>	<p>Over Error The incident light level is too low for the power tuning target value. The power can be increased up to approximately 1.5 times the incident light level without power tuning.</p>
<p>Flashes twice PtUn botm PTUN BOTM</p>	<p>Bottom Error The incident light level is too high for the power tuning target value. The power can be decreased down to approximately 1/8th the incident light level without power tuning.</p>
<p>Flashes twice PtUn tout PTUN TOUT</p>	<p>Timeout Error An error occurred because the incident light level was not stable during power tuning. Make sure that the work-piece and Head are secured and retune the power.</p>

Clearing Method

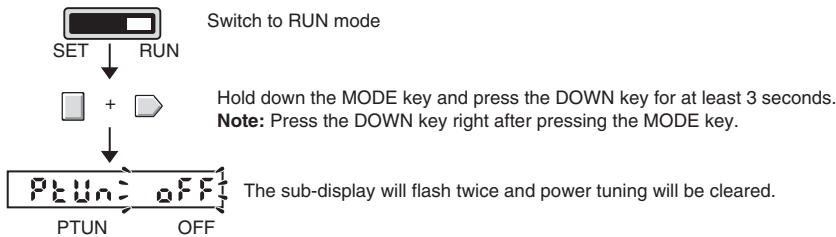

Setting Thresholds

Teaching for Through-beam or Retroflective Sensor Heads

Teaching for a Through-beam or Retroflective Sensor Head is performed without a workpiece. A value about 6% less than the incident light level is set as the threshold value. This method is ideal to stably detect very small differences in light level.

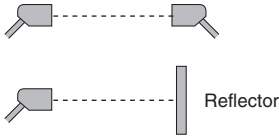

If DIFF (differential operation) is set for the detection method, the threshold value will be set to the minimum value below the incident light level without a workpiece that will enable stable detection.

Setting Mode

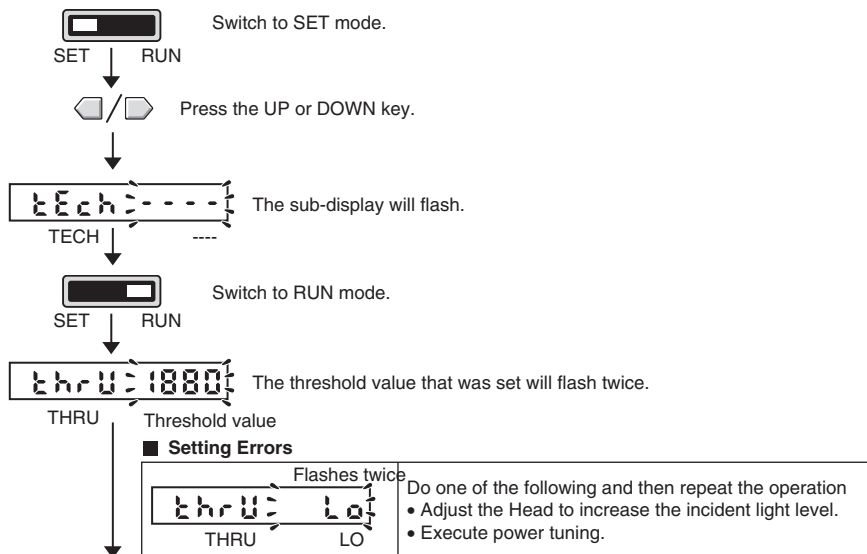

Teaching completed and previous display returns.

Teaching for Reflective Sensor Heads

Teaching for a Reflective Sensor Head is performed without a workpiece (i.e., for the background). A value about 6% greater than the incident light level is set as the threshold value. This method is ideal to stably detect very small differences in light level.



If DIFF (differential operation) is set for the detection method, the threshold value will be set to half of the difference between the two measured values.

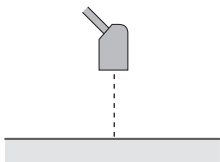

Setting Method

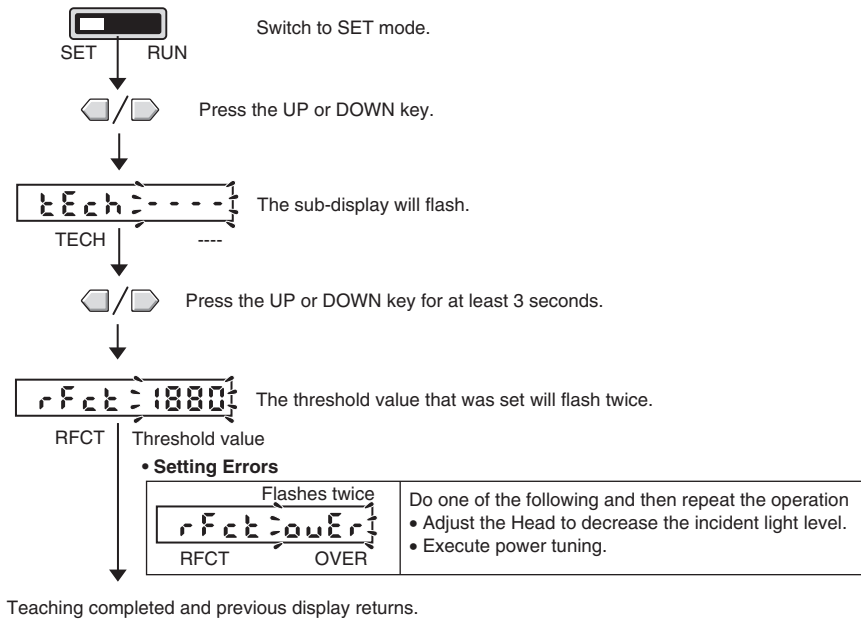

Teaching With and Without a Workpiece

Teaching can be performed twice, once with and once without a workpiece, and the value between the two measured values is set as the threshold.



If DIFF (differential operation) is set for the detection method, the threshold value will be set to half of the difference between the two measured values.

Setting Method

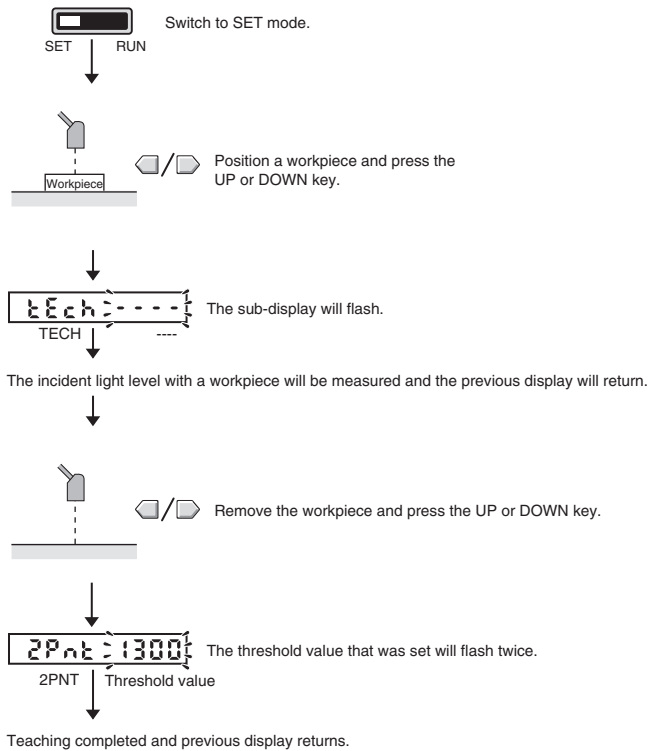

Setting Erros

An error has occurred if any of the following is display when the UP or DOWN key is pressed without a workpiece.

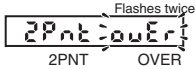
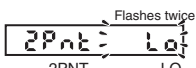
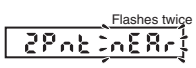
	<p>Do one of the following and then repeat the operation</p> <ul style="list-style-type: none"> Adjust the Head to decrease the incident light level. <ul style="list-style-type: none"> Execute power tuning.
	<p>Do one of the following and then repeat the operation</p> <ul style="list-style-type: none"> Adjust the Head to increase the incident light level. <ul style="list-style-type: none"> Execute power tuning.
	<p>Do the following and then repeat the operation</p> <ul style="list-style-type: none"> Adjust the Head to increase the difference between the two incident light levels.

Manually Setting Threshold Values

A threshold value can be set manually.

Setting Method

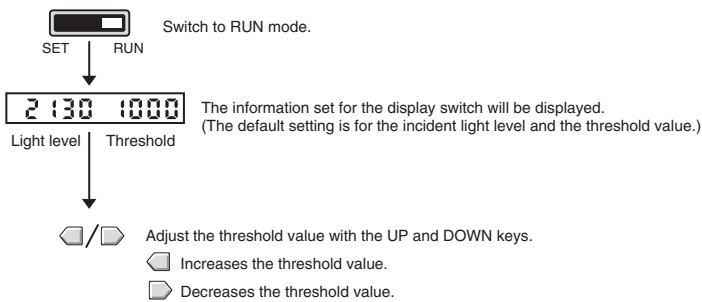

When the UP or DOWN key is pressed to change the threshold value, the threshold value will be displayed on the sub-display regardless of the display switch setting.

The information set for the display switch setting will return approximately 5 seconds after the threshold is changed.

Detailed Settings

The following functions can be set in SET mode. The default settings are shown in the transition boxes between functions. For Twin-output Models, all settings except for the operation mode and timer settings are the same for both channels.

Note: The values shown for thresholds, incident light levels, percentages, etc., are examples only. Actual displays may vary.

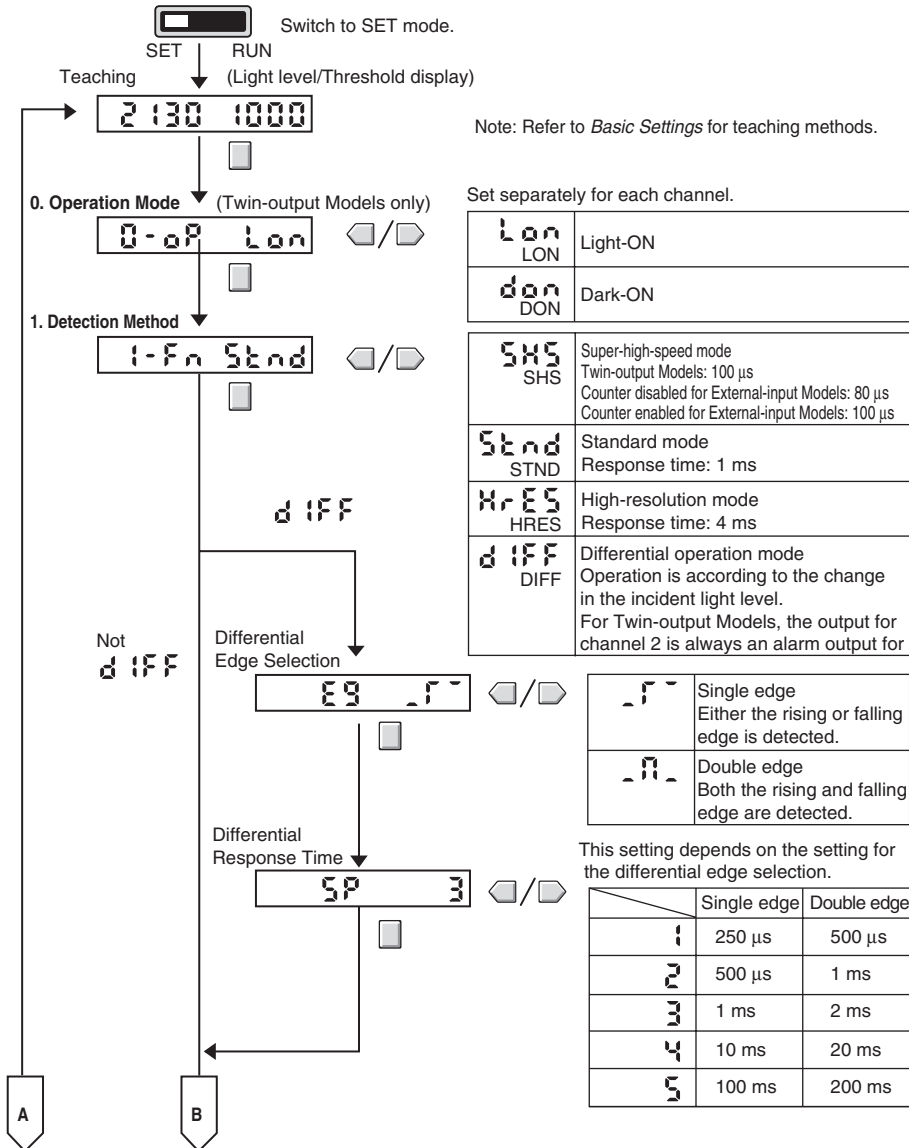

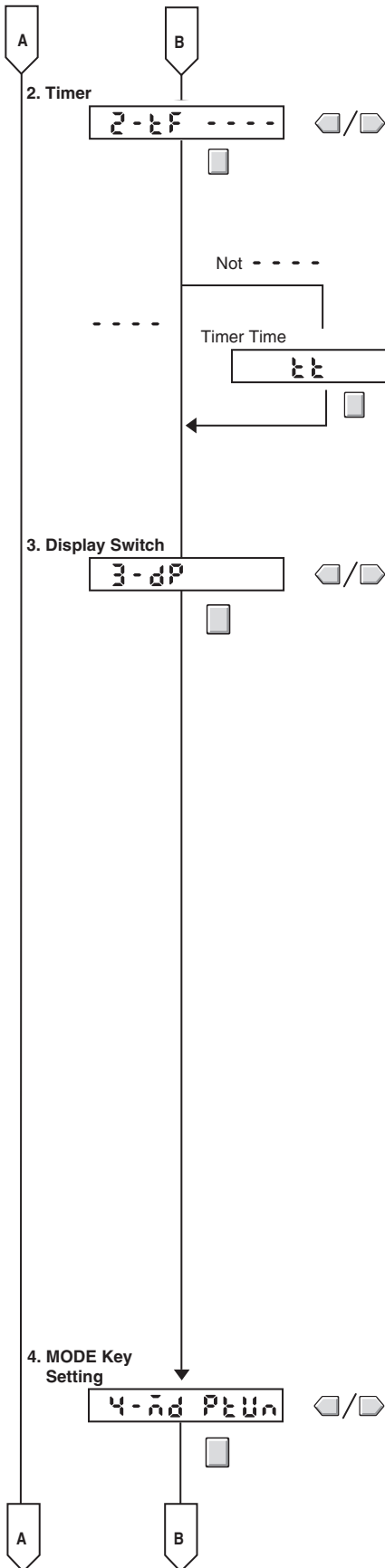

Set separately for each channel for Twin-output Models.

----	Timer disabled.
oFFd OFF D	OFF-delay timer
on-d ON-D	ON-delay timer
1ShE 1SHT	One-shot timer

Setting range: 1 to 5,000

1 to 20 ms	1-ms increments
20 to 200 ms	5-ms increments
200 ms to 1 s	100-ms increments
1 to 5 s	1-s increments

The information displayed in RUN mode can be selected. When going to SET mode, this setting will be ignored and the incident light level and threshold value will be displayed.

3 112 2000 Light level Threshold	The incident light level and threshold value
P 123 2000 % light level Threshold	The incident light level as a percentage of the threshold value and the threshold value.
L-PE d-bE L-PE D-BT	The incident light peak level and no incident light bottom level.
L-bE d-PE L-BT D-PE	The min. incident light peak level and max. no incident light bottom level. The display is updated for every 10 ON/OFF operations.
 Detection status	Analog bar display. The current detection status is displayed as an analog bar. The bar will lengthen from the right
3 112 PEAK Light level PEAK ⬆ Alternates at a fixed interval	The current incident light level and the peak incident light level.
3 112 3800 Light level Peak level	
3 112 2ch Light level Channel	The incident light level and the channel.
2999 999 Count	(External-input Models Only) The counter value.

The function of the MODE key in RUN mode can be selected.

PtUn PTUN	Tunes the power.
OrSt ORST	Executes a zero reset.
CrSt CRST	(External-input Models Only) Resets the counter.

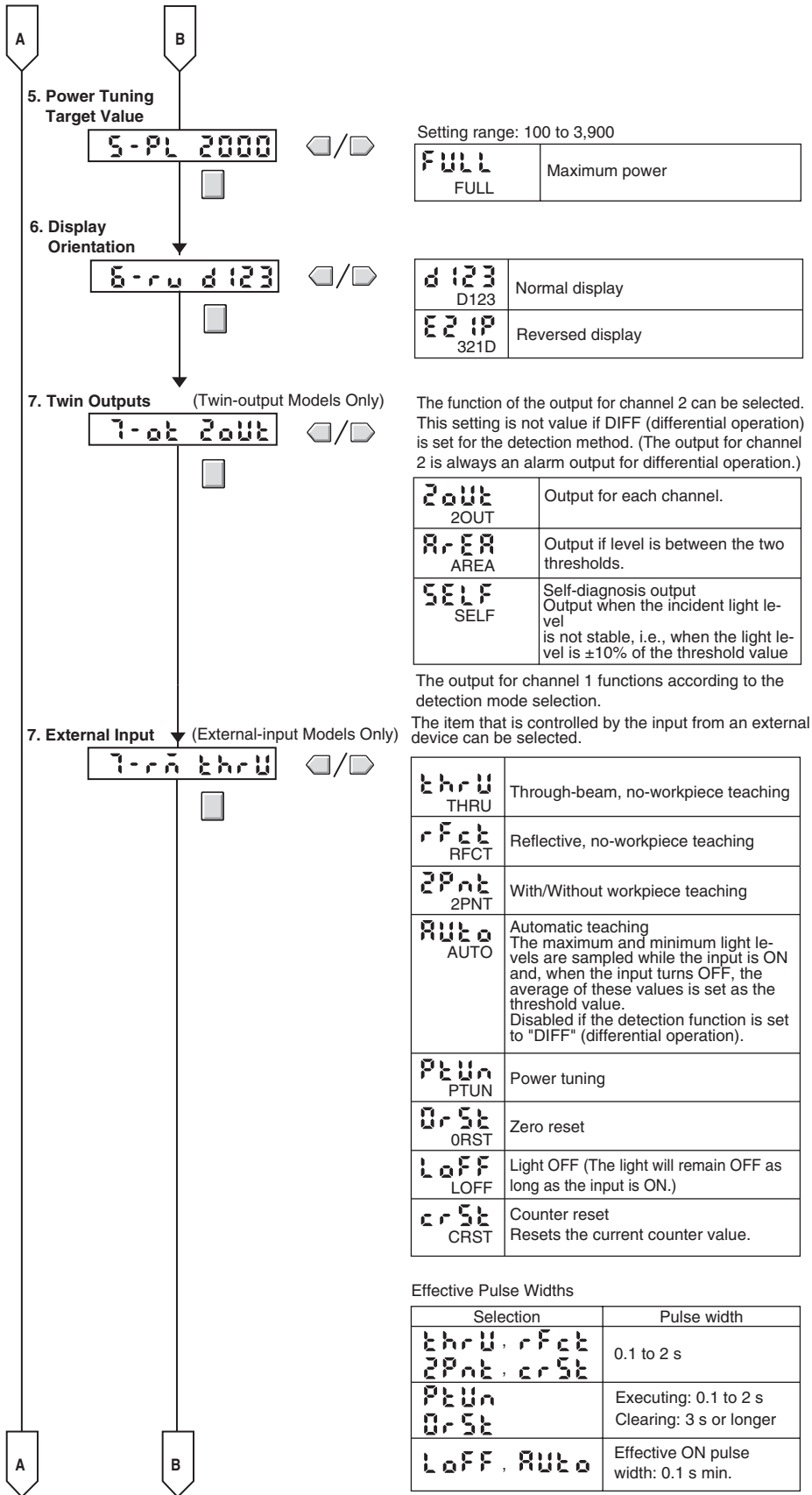

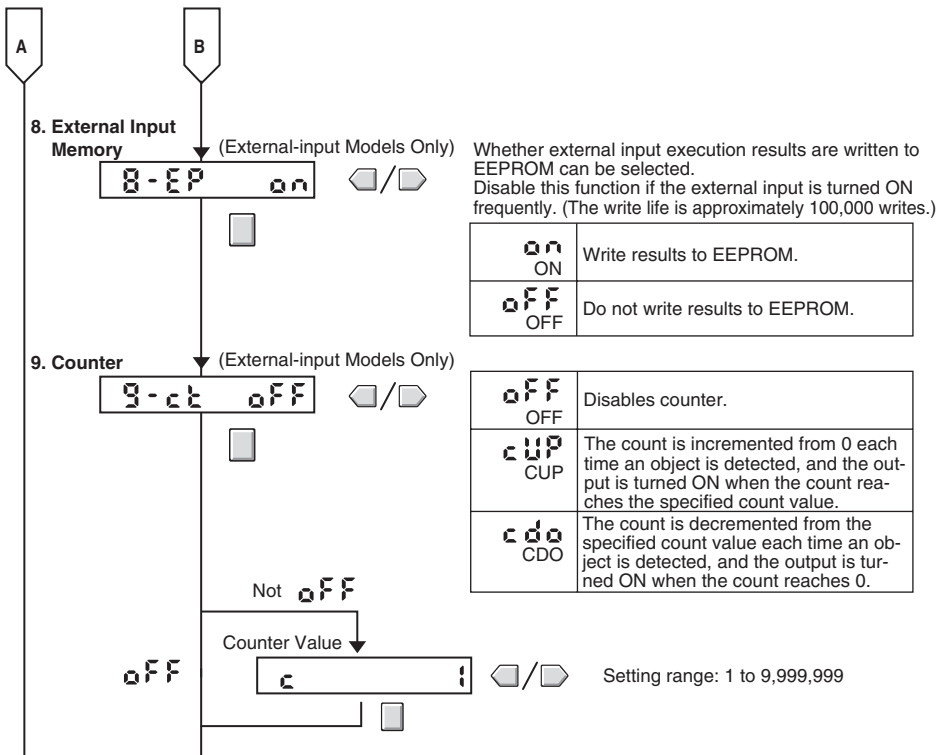

Convenient Functions

Zeroing the Main Display

The incident light level displayed on the main display can be zeroed. The threshold displayed in the sub-display is shifted by an amount corresponding to the amount the incident light level was changed.

Confirm that the MODE key setting is 0RST (zero reset) in advance. PTUN (power tuning) is the default setting. Refer to Detailed Settings.



Zero-reset is not possible if the detection function is set to "DIFF" (differential operation).

■ Setting Method

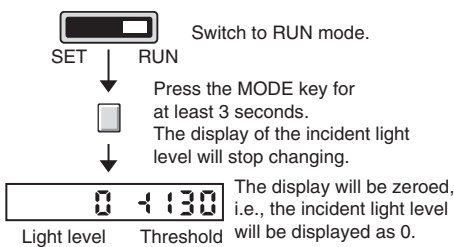

■ Clearing Method

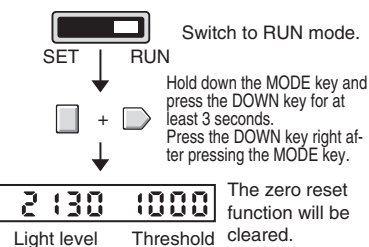

Key Lock

All key operations can be disabled to help prevent key operating errors. Only the operation keys are disabled. The switches and selectors will still function.

■ Setting Method

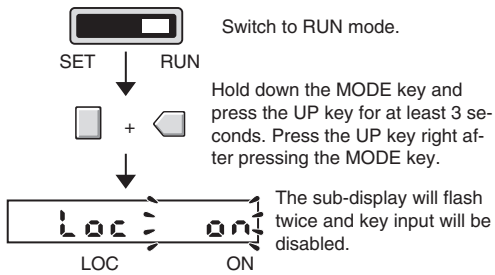

■ Clearing Method

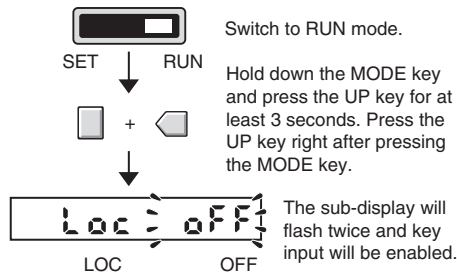

If a key is pressed while key operations are locked, "LOC" will flash twice on the display to indicate that key operations have been disabled.



Initializing Settings

This procedure can be used to return all the settings to the original default values.

■ Setting Method

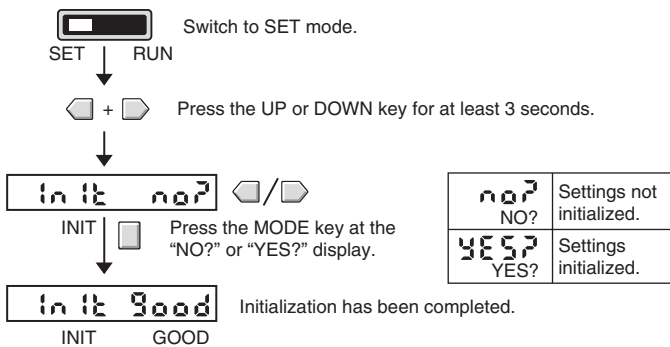

Installing the Amplifier Unit

Mounting Units

Catch the hook on the Sensor Head connector end of the Unit on the DIN Track and then press down on the other end of the Unit until it locks into place.

Always attach the Sensor Head connector end first.

If the incorrect end is attached first, the mounting strength will be reduced.

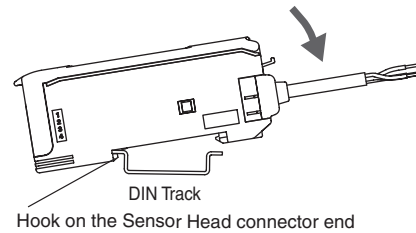

Removing Units

Press the Unit in the direction indicated by "1" and then lift up on the Sensor Head connector end of the Unit in the direction indicated by "2."

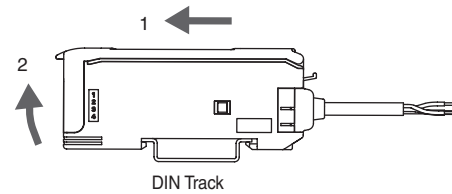

Joining Amplifier Units (for Units with Connectors)

Up to 16 Units can be joined.

1. Mount the Amplifier Units one at a time onto the DIN Track.
2. Slide the Amplifier Units together and press the Amplifier Units together until they click into place.

Secure the Units with an End Plate (PFP-M) if there is a possibility of the Amplifier Units moving, e.g., due to vibration. Reverse the above procedure to separate and remove the Units. Do not attempt to remove Amplifier Units from the DIN Track without separating them first.

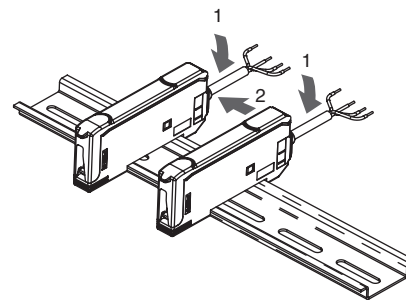

Connecting Sensor Heads

1. Open the protective cover
2. Making sure that the lock button is up, insert the fibers all the way to the back of the connector insertion opening.

To disconnect the Sensor Head, pull out the fibers while pressing on the lock button.

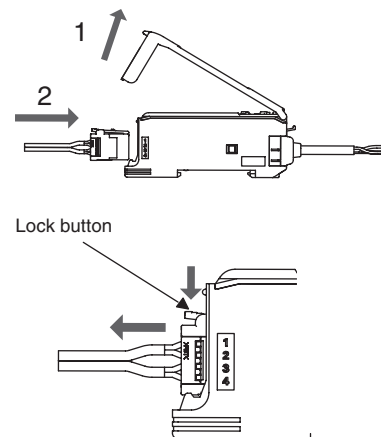

I/O Circuits

■ E3C-LDA11 and E3C-LD6 (NPN Models)

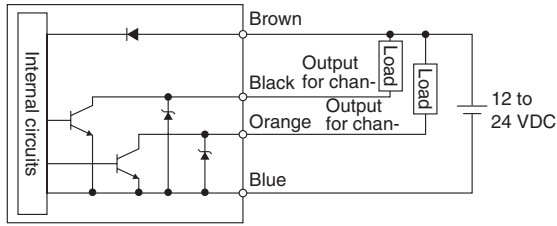

■ E3C-LDA41 and E3C-LD8 (PNP Models)

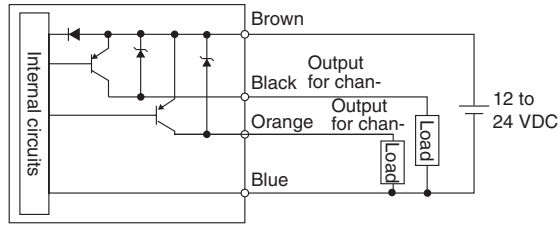

■ E3C-LDA21 and E3C-LD7 (NPN Models)

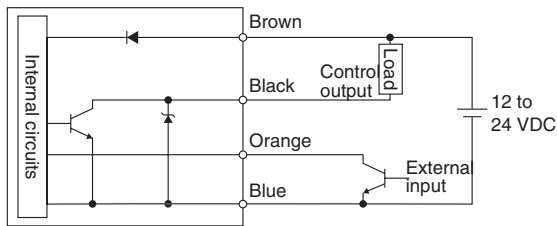

■ E3C-LDA51 and E3C-LD9 (PNP Models)

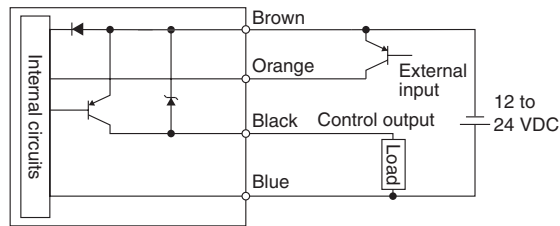

Dimensions

Sensor Head

E3C-LD11

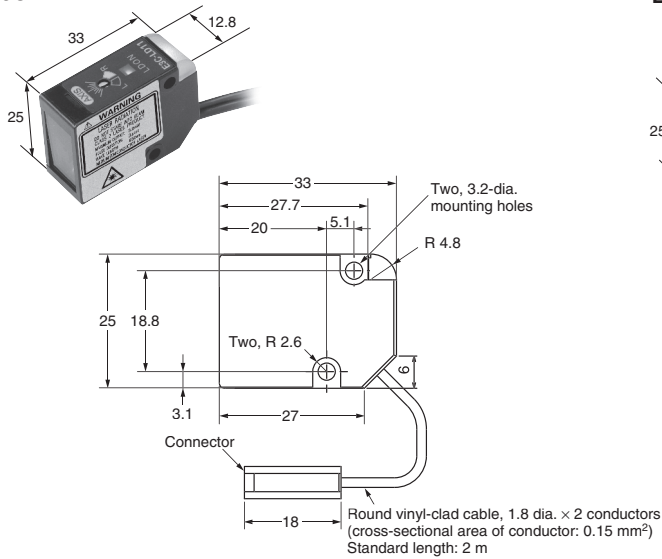

E3C-LR11

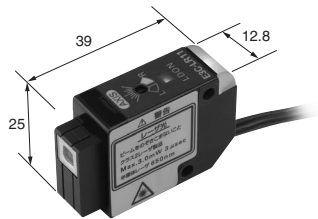

Reflector

E39-R12/R14

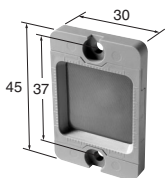

E39-R13

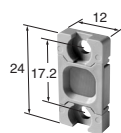

Amplifier Unit

E3C-LDA11

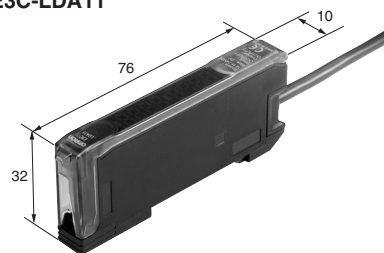

ALL DIMENSIONS SHOWN ARE IN MILLIMETERS.

To convert millimeters into inches, multiply by 0.03937. To convert grams into ounces, multiply by 0.03527.