

Transparent Object Detection Sensor

E3S-R

- Senses glass wafers and LCD glass circuit boards.



CE

Applications

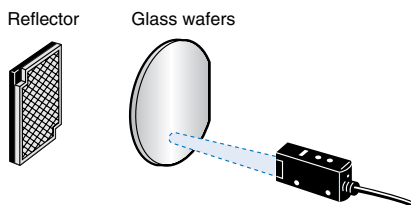

Sensing of Glass Wafers and LCD Glass Circuit Bottles



Ordering Information

Sensors

 Red light

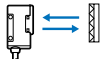
Sensor type	Shape	Connection method	Sensing distance	Model	
				NPN output	PNP output
Retroreflective Models	Horizontal 	Pre-wired	 1m [100mm] *	E3S-R11	E3S-R31
		Connector type		E3S-R16	E3S-R36
	Vertical 	Pre-wired		E3S-R61	E3S-R81
		Connector type		E3S-R66	E3S-R86

* Values in parentheses indicate the minimum required distance between the sensor and reflector.







Note: Stable detection may not be possible of some glass wafer materials. Be sure to test whether the work can be detected.

Accessories (Order Separately)

Reflectors



Name	Sensing distance	Model	Quantity	Remarks
Reflectors	Refer to ratings/performance	E39-R1	1	Supplied with the product.

Clamps/Other

Shape	Model	Quantity	Remarks
	E39-L69	1	Included as an accessory for the horizontal model.
	E39-L70	1	Included as an accessory for the vertical model.
	E39-L93	One set	Sensor adjuster: Easy mounting and adjustment on aluminum frame and rail of conveyors and other equipment.
	E39-L97	1	Horizontal protective cover clamp.
	E39-L98	1	Vertical protective cover clamp.
	E39-L60	1	Contact mounting plate: Accessory to E3S-R□.

Note: 1. If a through-beam model is used, order two Mounting Brackets for the emitter and receiver respectively.
2. For details, refer to "Mounting bracket list".

Sensor I/O Connectors

Cable	Shape	Cable length		Model
Standard cable	Straight 	2 m	3-wire type	XS2F-D421-DC0-A
		5 m		XS2F-D421-GC0-A
	L-shape 	2 m		XS2F-D422-DC0-A
		5 m		XS2F-D422-GC0-A

Rating/performance

Item	Sensor type		Retroreflective Models (with M.S.R)
	Model	NPN output	E3S-R11/-R16/-R61/-R66
		PNP output	E3S-R31/-R36/-R81/-R86
Sensing distance	1 m (100 mm) *1(When using the E39-R1)		
Standard sensing object	75-mm dia. or larger opaque LCD glass plate (thickness: 0.7 mm)		
Directional angle	3 to 10°		
Light source (wave length)	Red LED (700 nm)		
Power supply voltage	10 to 30 V DC (including 10% ripple (p- p))		
Current consumption	30 mA max.		
Control output	Load supply voltage: 30 VDC or less, load current: 100 mA or less (residual voltage of 1 V or less), NPN open collector output, Light ON / Dark ON switching		
Protective circuits	Reverse polarity protection, output short-circuit protection, mutual interference prevention		
Response time	Operation or reset: 1 ms max.		
Sensitivity adjustment	2-revolution endless volume		
Ambient illuminance	Incandescent lamp: 5,000 lux max. Sunlight 10,000 lux max.		
Ambient temperature	Operating: 0 to +40°C, storage: -40 to +70°C (no ice formation or condensation)		
Ambient humidity	Operating: 35 to 85% RH, Storage: 35 to 95% RH (no condensation)		
Insulation resistance	20 M min. at 500 VDC		
Dielectric strength	1,000 VAC at 50/60 Hz for 1 minute		
Vibration resistance	10 to 55 Hz, 1.5 mm double amplitude for 2 hours each in X, Y, and Z directions		
Shock resistance	Destruction: 500 m/s ² for 3 times each in X, Y, and Z directions		
Protective structure	IEC 60529 IP67		
Connection method	Pull-out cable type (standard cord length: 2 m) / connector type		
Weight (Packed state)	Approximately 110 g (pull-out cable type) Approximately 60 g (connector type)		
Material	Case	PBT (polybutylene terephthalate)	
	Lens	Denatured polyarylate	
	Mounting Brackets	Stainless steel (SUS304)	
Accessories	Clamps (with screws), operation manual, reflector		

*1. Values in parentheses indicate the minimum required distance between the sensor and reflector.

Characteristic data (typical)

Operating Range

E3S-R11, E3S-R61+ E39R1

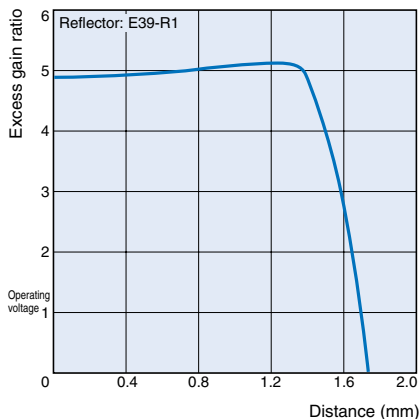

Changes in light intensity when detecting various transparent objects (Note 1)

The following are the permeation rates of a various transparent objects on condition that a permeation rate of 100 means that there is no object within the sensing distance of the E3S-R. The permeation rate of any type of object sensed by the E3S-R must be as low as possible for the stable sensing of the object. Before using the E3S-R to sense objects, use samples of the objects to check if the E3S-R can sense the samples easily.

Sensing object Shape	Model Passage position	E3S-R11, R61, R81; E3S-R16, R66, R36, R86
		Center
Glass plate	50 x 50 t = 0.5	82
	50 x 50 t = 1	74
	50 x 50 t = 2	73
	50 x 50 t = 3	62
	50 x 50 t = 10	38
Liquid crystal glass	t = 0.5 (98% transparency)	86
	t = 0.7 (95% transparency)	81
	t = 1.1 (91% transparency)	75
Operating range		95 max.
Stable operating range		90 max.

Note: 1. The sensing distance of each model was set to the rated sensing distance.
 2. The permeability values were checked with light with a wavelength of 700 nm.

Output Circuit Diagram

NPN output

Model	Operating status of output transistor	Timing chart	Mode selection switch	Output circuit
E3S-R11 E3S-R61 E3S-R16 E3S-R66	Light ON	Incident Interrupted Light indicator (red) ON OFF Output transistor ON OFF Load (Relay) Operate Reset (Between brown and black)	L•ON	<p>Connector Pin arrangement</p> <p>Note: Terminal 2 is not used.</p>
	Dark ON	Incident Interrupted Light indicator (red) ON OFF Output transistor ON OFF Load (Relay) Operate Reset (Between brown and black)	D•ON	<p>Connector Pin arrangement</p> <p>Note: Terminal 2 is not used.</p>

PNP output

Model	Operating status of output transistor	Timing chart	Mode selection switch	Output circuit
E3S-R31 E3S-R36 E3S-R81 E3S-R86	Light ON	Incident Interrupted Light indicator (red) ON OFF Output transistor ON OFF Load (Relay) Operate Reset (Between blue and black)	L•ON	<p>Connector Pin arrangement</p> <p>Note: Terminal 2 is not used.</p>
	Dark ON	Incident Interrupted Light indicator (red) ON OFF Output transistor ON OFF Load (Relay) Operate Reset (Between blue and black)	D•ON	<p>Connector Pin arrangement</p> <p>Note: Terminal 2 is not used.</p>

Connectors (Sensor I/O connectors)

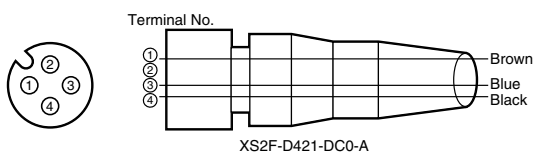

Class	Wire, outer jacket color	Connector pin No.	Application
For DC	Brown	①	+V
	---	②	---
	Blue	③	0V
	Black	④	Output

Note: Pin 2 is not used.

Precautions

Correct Use

- For adjustment
- The passage point of the detection object should be the central point between the reflective plate and the photoelectric switch. If too close to the reflective plate, an error may result.
- To obtain sufficient detection performance, the E39-R1 must be used for the reflective plate unless otherwise specified.

Dimensions (Unit: mm)

Sensors

Horizontal type

Pre-wired

E3S-R11

E3S-R31

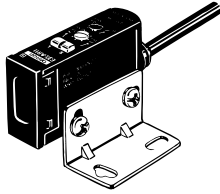

With Mounting Blanket Attached

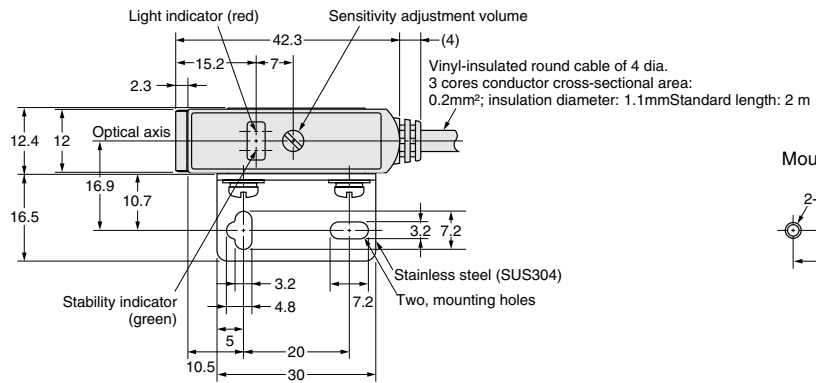

Mounting Holes

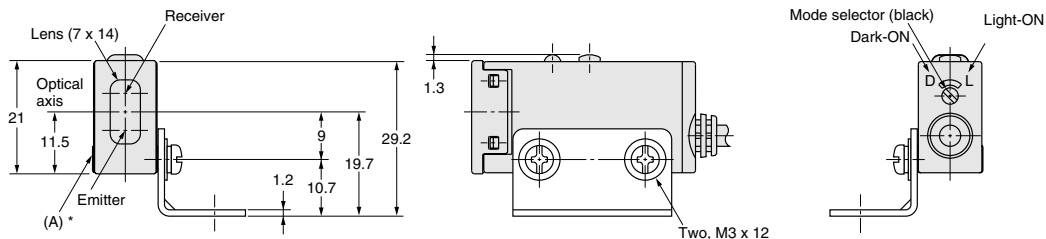
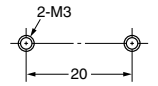

* The Mounting Bracket can also be used on side A.

Connector type

E3S-R16

E3S-R36

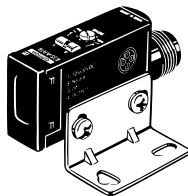

With Mounting Blanket Attached

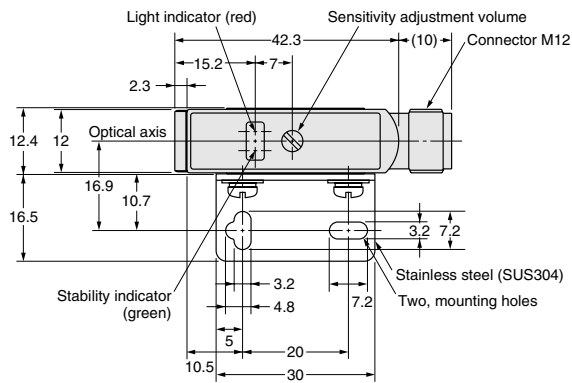

Mounting Holes

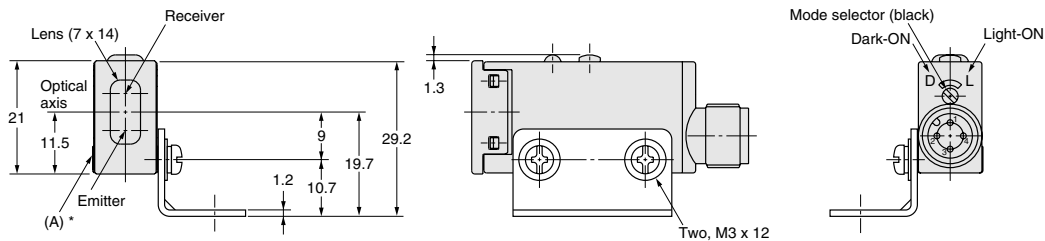
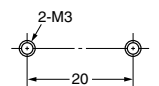

* The Mounting Bracket can also be used on side A.

Vertical type

Pre-wired

E3S-R61
E3S-R81

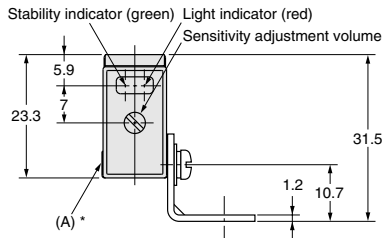
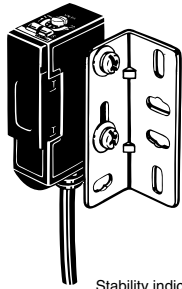

* Mounting Bracket can be attached to side A.

With Mounting Blanket Attached

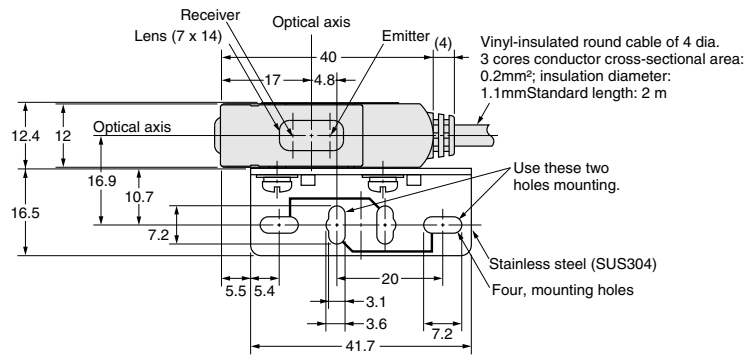

Mounting Holes

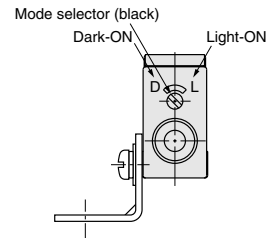
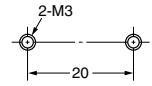

Connector type

E3S-R66
E3S-R86

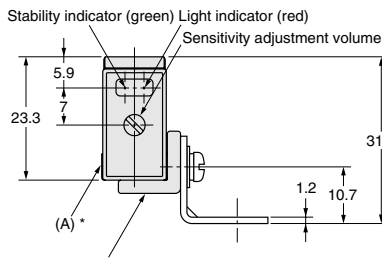
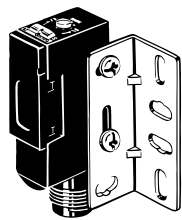

E39-L60 Close Mounting Plate (attachment)
(Attach the mounting plate or the plug cannot be connected.)

* Mounting Bracket can be attached to side A.

With Mounting Blanket Attached

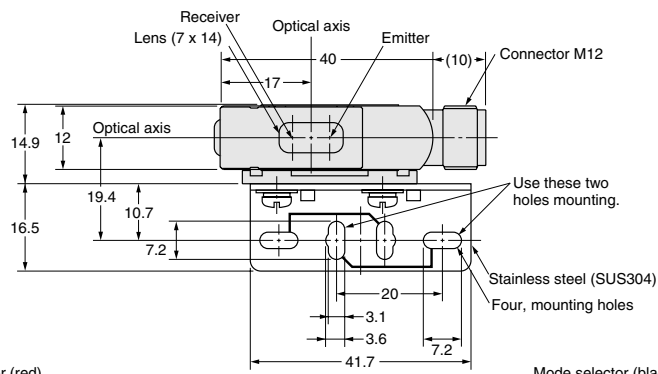

Mounting Holes

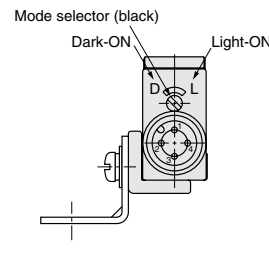
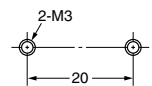

Accessories (Order Separately)

H-5

ALL DIMENSIONS SHOWN ARE IN MILLIMETERS.
To convert millimeters into inches, multiply by 0.03937. To convert grams into ounces, multiply by 0.03527.