

Process Meter K3MA-J

Highly Visible LCD Display with 2-color (Red and Green) LEDs

- Multi-range DC voltage/current input.
- Front-panel key operation for easy setting.
- Average processing function suppresses flicker.
- Scaling, front-panel forced-zero, zero-limit functions.
- Easy confirmation of max/min display.
- Short 80-mm depth (measured from edge of face plate).
- Finger protective cover (standard equipment) guards against electric shock.
- Water- and dust-proof NEMA4X (IP66 equivalent) front panel.
- Recognized to U.S. and Canadian requirements under the Component Recognition Program of UL.
- CE marking.



Digital panel indicators

Model Number Structure

Model Number Legend

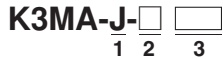

- 1. Input Type**
J: DC voltage/current
- 2. Output Type**
None: No output
A2: 2 relay contact outputs (SPST-NO)
- 3. Supply Voltage**
100-240VAC: 100 to 240 VAC
24VAC/VDC: 24 VAC/VDC

Ordering Information

List of Models

Input type	Supply voltage	Output	Model
DC voltage/current	100 to 240 VAC	None	K3MA-J 100-240VAC
		2 relay contact outputs (SPST-NO)	K3MA-J-A2 100-240VAC
	24 VAC/VDC	None	K3MA-J 24VAC/VDC
		2 relay contact outputs (SPST-NO)	K3MA-J-A2 24VAC/VDC

Accessories (Order Separately)

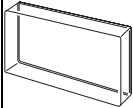
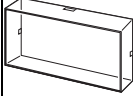
Name	Shape	Model
Splash-proof Soft Cover		K32-49SC
Hard Cover		K32-49HC

Specifications

■ Ratings

Model	K3MA-J 100-240VAC, K3MA-J-A2 100-240VAC	K3MA-J 24VAC/VDC, K3MA-J-A2 24VAC/VDC
Supply voltage	100 to 240 VAC	24 VAC/VDC
Operating voltage range	85% to 110% of the rated supply voltage	
Power consumption (under maximum load)	6 VA max.	4.5 VA max. (24 VAC) 4.5 W max. (24 VDC)
Insulation resistance	20 M Ω min. (at 500 VDC) between external terminal and case. Insulation provided between inputs, outputs, and power supply.	
Dielectric strength	2,000 VAC for 1 min between external terminal and case. Insulation provided between inputs, outputs, and power supply.	
Noise immunity	\pm 1,500 V on power supply terminals in normal or common mode. \pm 1 μ s, or 100 ns for square-wave noise with 1 ns.	\pm 480 V on power supply terminals in normal mode. \pm 1,500 V in common mode. \pm 1 μ s, or 100 ns for square-wave noise with 1 ns.
Vibration resistance	Vibration: 10 to 55 Hz, Acceleration: 50 m/s ² 5 min each in X, Y, and Z directions for 10 sweeps.	
Shock resistance	150 m/s ² (100 m/s ² for relay contact outputs) 3 times each on 3 axes, 6 directions.	
Ambient temperature	Operating:-10°C to 55°C (with no condensation or icing) Storage:-25°C to 65°C (with no condensation or icing)	
Ambient humidity	Operating:25% to 85% (with no condensation)	
Approved safety standards	UL3121-1, conforms to EN61010-1 (Pollution degree 2/overvoltage category II) Conforms to VDE0106/P100 (finger protection)	
EMC	(EMI)EN61326+A1Industry Emission Enclosure:CISPR 11 Group 1 class A: CISRP16-1/-2 Emission AC Mains:CISPR 11 Group 1 class A: CISRP16-1/-2 (EMS)EN61326+A1Industry Immunity ESD:EN61000-4-2:4 kV contact discharge 8 kV air discharge Immunity RF-interference:EN61000-4-3:10 V/m (amplitude-modulated, 80 MHz to 1 GHz) Electrical Fast Transient Noise:EN61000-4-4:2 kV (power line) Immunity Burst Noise:1 kV line to line (I/O signal line) Immunity Surge:EN61000-4-5:1 kV (power line) 2 kV line to ground (power line) Immunity Conducted Disturbance:EN61000-4-6:3 V (0.15 to 80 MHz) Immunity Voltage Dip/Interrupting:EN61000-4-11:0.5 cycle, 0, 180°, 100% (rated voltage)	
Weight	Approx. 200 g	

■ Characteristics

Input signal	DC voltage/current (0 to 20 mA, 4 to 20 mA, 0 to 5 V, 1 to 5 V, ± 5 V, ± 10 V)
A/D conversion	Double integral method
Sampling period	250 ms
Display refresh period	Sampling period (sampling times multiplied by number of measurements for averaging if average processing is selected.)
Max. displayed digits	5 digits (-19999 to 99999)
Display	7-segment digital display, Character height: 14.2 mm
Polarity display	"-" is displayed automatically with a negative input signal.
Zero display	Leading zeros are not displayed.
Scaling function	Programmable with front-panel key inputs (range of display: -19999 to 99999). The decimal point position can be set as desired.
Hold function	Max. hold (maximum value), Min. hold (minimum value)
Hysteresis setting	Programmable with front-panel key inputs (0001 to 9999).
Other functions	Forced-zero (with front-panel key) Zero-limit Scaling teach function Display color change (green (red), green, red (green), red) OUT type change (upper limit, lower limit, upper/lower limit) Average processing (simple average)
Output	Relays: 2 SPST-NO
Delay in comparative outputs	750 ms max.
Degree of protection	Front panel: NEMA4X for indoor use (equivalent to IP66) Rear case: IEC standard IP20 Terminals: IEC standard IP00 + finger protection (VDE0106/100)
Memory protection	Non-volatile memory (EEPROM) (possible to rewrite 100,000 times)

■ Measuring Ranges

Process Voltage/Current Inputs

Input	Measuring range	Measuring accuracy	Input impedance	Displayable range
DC voltage	1.000 to 5.000 V	$\pm 0.1\%$ FS ± 1 digit max. (at $23\pm 3^\circ\text{C}$)	1 M Ω min.	-19999 to 99999 (with scaling function)
	0.000 to 5.000 V			
	-5.000 to 5.000 V	$\pm 0.1\%$ FS ± 1 digit max. (at $23\pm 5^\circ\text{C}$)		
	-10.00 to 10.00 V			
DC current	4.00 to 20.00 mA/ 0.00 to 20.00 mA	$\pm 0.1\%$ FS ± 1 digit max. (at $23\pm 3^\circ\text{C}$)	45 Ω	

■ Input/Output Ratings

Relay Contact Output

Item	Resistive load ($\cos\phi = 1$)	Inductive load ($\cos\phi = 0.4$, L/R=7 ms)
Rated load (UL ratings)	5 A at 250 VAC, 5 A at 30 VDC	1.5 A at 250 VAC, 1.5 A at 30 VDC
Rated carry current	5 A max. (at COM terminal)	
Max. contact voltage	250 VAC, 150 VDC	
Max. contact current	5 A (at COM terminal)	
Max. switching capacity	1,250 VA, 150 W	250 VA, 30 W
Min. permissible load (P level, reference value)	10 mA at 5 VDC	
Mechanical life	5,000,000 times min. (at a switching frequency of 1,200 times/min)	
Electrical life (at an ambient temperature of 20°C)	100,000 times min. (at a rated load switching frequency of 10 times/min)	

Connections

Terminal Arrangement

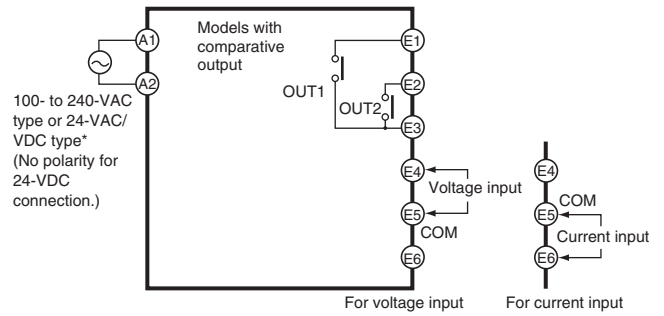
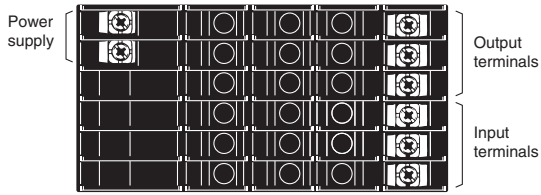

*Recommended DC power supply: eg. ORMON S8VS

Terminal No.	Name	Description
A1 - A2	Operation power	Connects the operation power supply.
E4, E6 - E5	Analog input	Connects the voltage or current analog input.
E1, E2 - E3	Outputs	Outputs the relay outputs.

Block Diagram

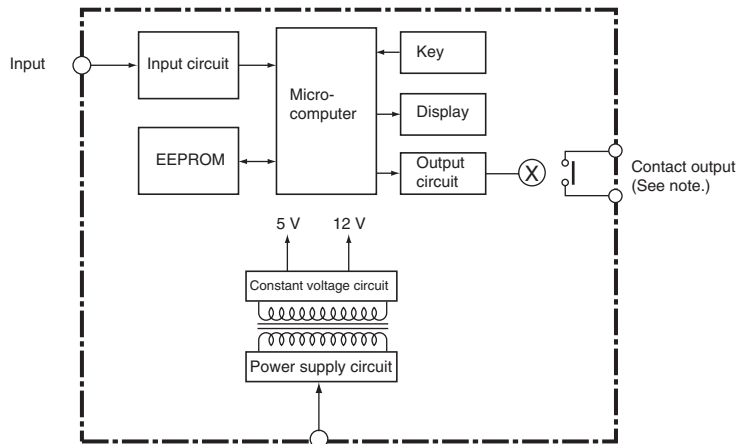

Note: Relay output models only.

Input Circuits

Analog Input (DC Voltage/Current)

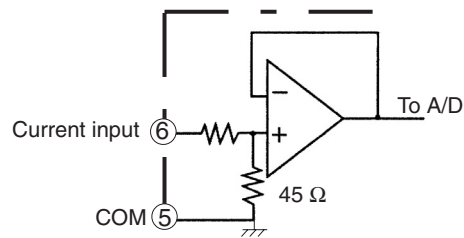
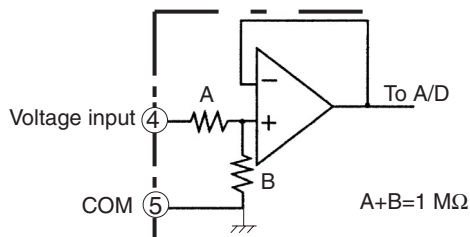

Operation

■ Main Functions

Input Types and Ranges

Input type (setting parameter)	Function	Input range (setting parameters)	Setting range
Input range ($\bar{c}n-t$)	Selects DC voltage/current signal input	0 to 20 mA ($\bar{0}-2\bar{0}$) 4 to 20 mA ($\bar{4}-2\bar{0}$) 0 to 5 V ($\bar{0}-5$) 1 to 5 V ($\bar{1}-5$) ± 5 V ($\bar{5}$) ± 10 V ($\bar{10}$)	Displayable from -19999 to 99999 with scaling function. The position of the decimal point can be set as desired.

Note: The initial value for the input range is "4 to 20 mA ($\bar{4}-2\bar{0}$)."

Scaling

- Analog (Process) Inputs

The K3MA-J converts input signals into desired physical values.

When DISPLAY1 is set for INPUT1, and DISPLAY2 is set for INPUT2, a line will be displayed joining the two points. (Raise shift, reverse scaling, plus/minus display, etc., can be adjusted as desired.)

INPUT2:Any input value
DISPLAY2:Displayed value corresponding to INPUT2
INPUT1:Any input value
DISPLAY1:Displayed value corresponding to INPUT1

Parameter	Setting value	Meaning
inp.1	- 19999 to 99999	Input value for $dSP.1$
dsp.1	- 19999 to 99999	Display value for $\bar{c}nP.1$
inp.2	- 19999 to 99999	Input value for $dSP.2$
dsp.2	- 19999 to 99999	Display value for $\bar{c}nP.2$

Parameter	Setting value	Meaning
dp	%.%.%.%	Display four digits after decimal point
	%.%.%.%	Display three digits after decimal point
	%.%.%.%	Display two digits after decimal point
	%.%.%.%	Display one digit after decimal point
	%.%.%.%	No decimal point

Digital panel indicators

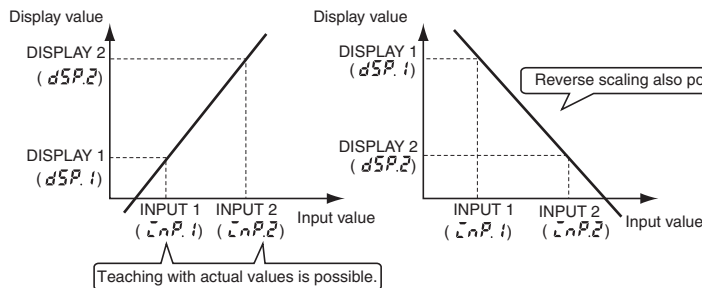

The decimal point can be optionally displayed. When displaying the decimal point, consider the number of digits to follow the decimal point prior to setting the scaling display value.

Reverse scaling, where the display value decreases as the input value increases, is also possible.

Instead of setting by inputting with the $\bar{\Delta}$ Up Key and $\bar{\square}$ Shift Key, current values can be input as scaling input values for teaching. This is useful for making settings while checking the operation status of the K3MA-J.

Convenient Functions

Scaling Teach

The parameters ($\bar{C}nP.1$, $\bar{C}nP.2$) for the K3MA-J's initial setting level can be set using actual input values with the teaching function. After displaying the parameters, the actual input settings can be made with the following operation.

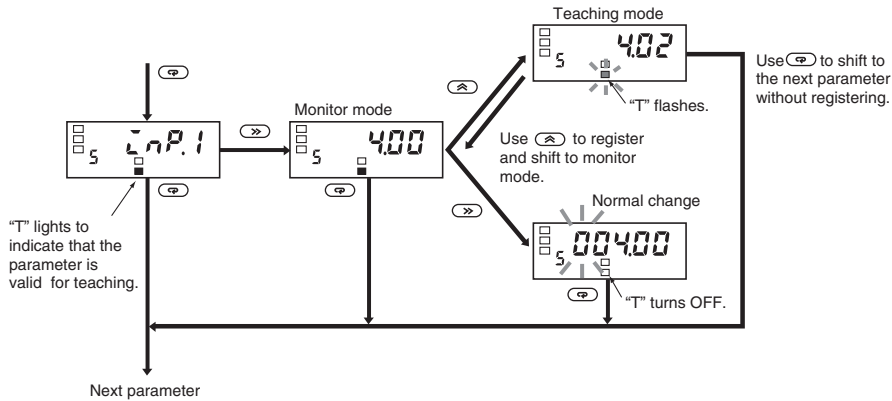

OUT Types (Comparative Output Models Only)

OUT 1 and OUT 2 can be set to operate in one of the three following modes in accordance with the compared values:

- **Upper limit (High Acting):**
The output is turned ON when the measurement value is greater than its set value.
- **Lower limit (Low Acting):**
The output is turned ON when the measurement value is less than its set value.
- **Upper and lower limits (Outside Band Acting):**
An upper limit (H set value) and lower limit (L set value) can be set independently.
The output is turned ON when the measurement value is greater than upper-limit set value or less than the lower-limit set value.

Upper Limit (High Acting)

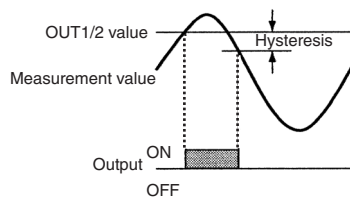

Lower Limit (Low Acting)

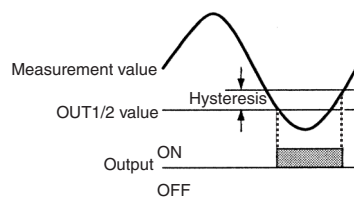

Upper and Lower Limits (Outside Band Acting)

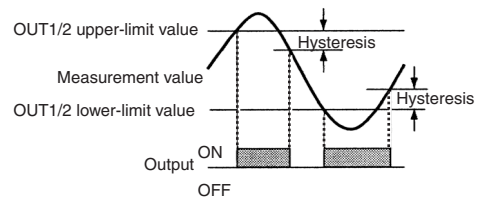

The three types of output operations shown above can be combined as desired. The following are examples of possible combinations.

Upper Limit 2-stage Output

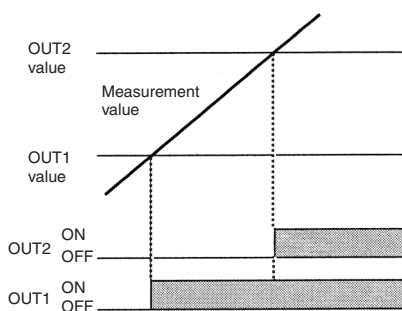

Threshold Output

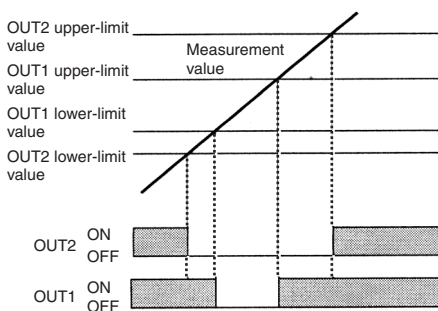

Combination of Upper Limit and Upper/Lower Limits

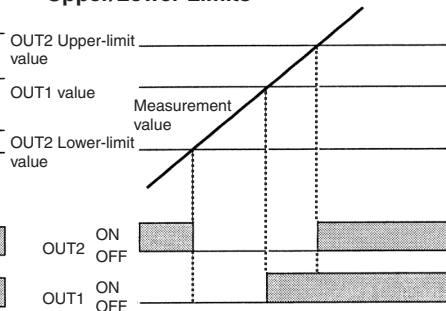

Parameter Initialization

This function returns all of the parameters to their initial values.

Parameter	Setting value	Meaning
init	off	---
	on	Initializes all parameters.

Use this to reset the K3MA-J after returning it to its factory-set condition.

Average Processing

Average processing stabilizes displayed values to minimize flicker by averaging the fluctuating input signals. Average processing can be performed for the measurement values in either of four steps (OFF, 2 times, 4 times, or 8 times).

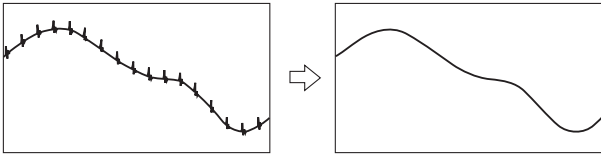

This is useful for ignoring rapid fluctuations, e.g., eliminating spike noise.

Hysteresis (Comparative Output Models Only)

The hysteresis of comparative outputs can be set to prevent chattering in the output when the measurement value fluctuates finely near the OUT value.

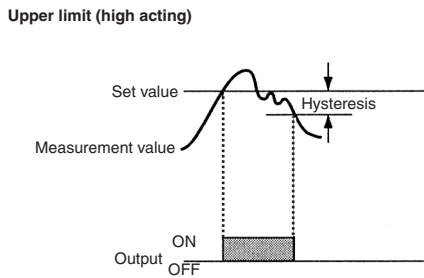

Zero-limit Function

The zero-limit function changes any value below the set value to zero. This is useful when you want to change negative values to zero rather than display them, or when you want to make the display in the smallest part of the input range zero.

Parameter	Setting value	Meaning
=-lim	off	OFF: No zero-limit
	on	ON: Zero-limit
lim-p	0 to 99	0 to 99: Zero-limit value

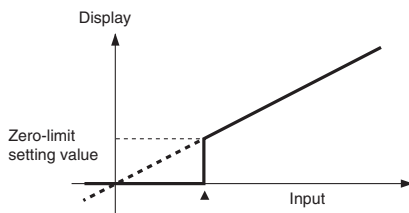

Changing the Display Color

The color of the value displayed can be set to either red or green. For comparative output models, the display color can be set to change from green to red, or from red to green, according to the status of the comparison criterion.

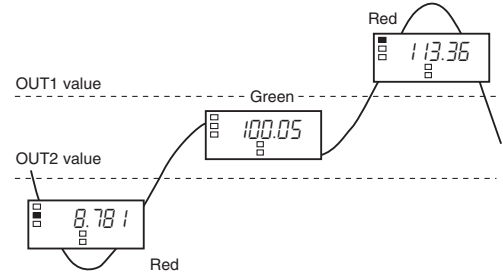

Display Auto-return Time

This function automatically returns the display to the operation level's current value if no keys are pressed for a preset time (called the display auto-return time).

Move-to-Protect-Level Time

The time required to shift to the protect level can be set as desired.

Forced-zero Function

It is possible to shift from a value to the zero point with one touch of the Up Key on the front panel (for example, when adjusting reference values).



Note: Used only for releasing the forced-zero with the Protect menu.

MAX/MIN Display

The maximum and minimum measurement (display) values from the time the power is turned ON until the current time can be stored and displayed. This is useful, for example, when measuring the maximum value.

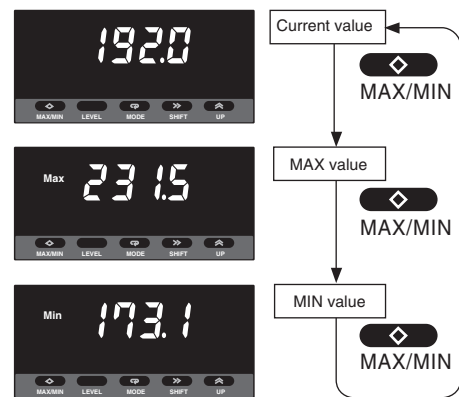

Nomenclature

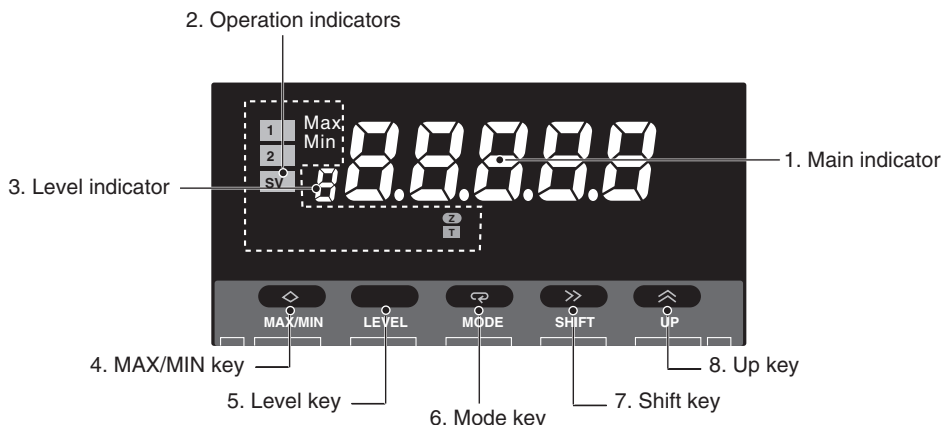

Name	Functions
1. Main indicator	Displays current values, parameters, and set values.
2. Operation indicators	1 Lit when output 1 is ON.
	2 Lit when output 2 is ON.
	SV Lit when a set value is being displayed or changed.
	Max Lit when the main indicator is showing the MAX value.
	Min Lit when the main indicator is showing the MIN value.
	Z Lit during the forced-zero operation.
	T Lit when the teaching function is operable. Blinks while the teaching function is operating.
3. Level indicator	Displays the current level that the K3MA-J is in. (See below for details.)
4. MAX/MIN Key	Used to display the MAX and MIN values when a measurement value is being displayed.
5. Level Key	Used to change the level.
6. Mode Key	Used to allow the main indicator to indicate parameters sequentially.
7. Shift Key	Used to enable a set value to be changed. When changing a set value, this key is used to move along the digits.
8. Up Key	Used to change a set value. Used to set or clear a forced-zero function when a measurement value is being displayed.

Level indicator	Level
p	Protect
Not lit	Operation
s	Initial setting
f	Advanced-function setting

Dimensions

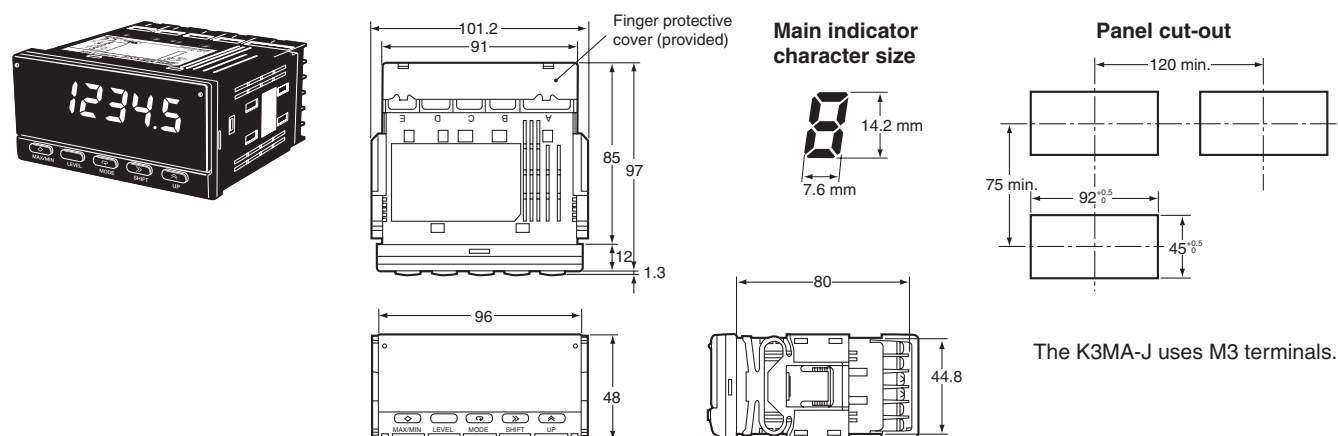

The K3MA-J uses M3 terminals.

Application Examples

Monitoring interior tank pressure

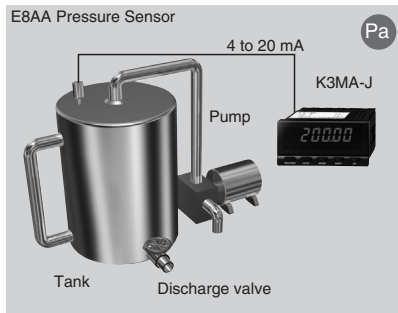

- Monitoring gas pressure
- Inspection instruments in food or pharmaceutical plants

Displaying/outputting liquid level

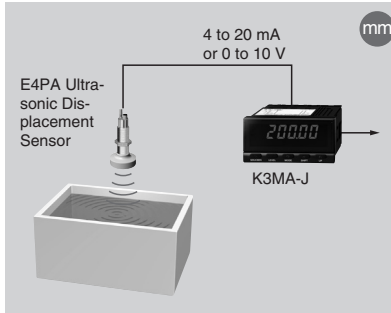

- Monitoring liquid level in cleaning tanks
- Water tanks, devices using chemicals, etc.

Flowrate sensor

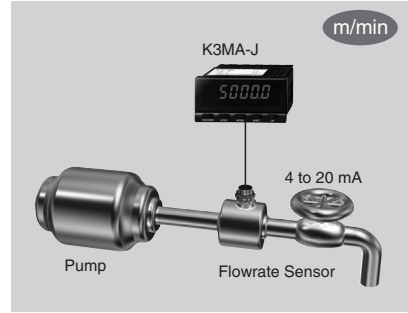

- Monitoring sendout flowrate
- Water processing devices, etc.

Installation

1. Insert the K3MA-J into the panel cut-out hole.
2. For a waterproof installation, insert the rubber gasket onto the body of the K3MA-J.

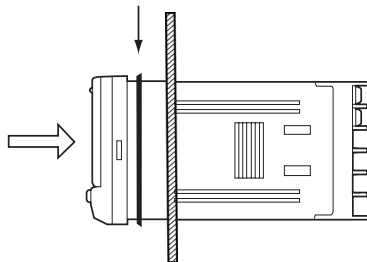

3. Fit the adaptor into the grooves on the left and right sides of the rear case, then push it until it contacts the panel to secure the K3MA-J.

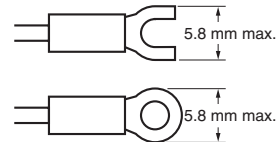
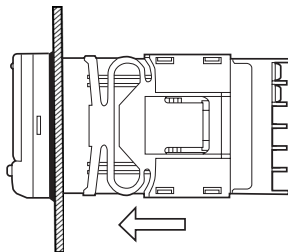

Unit Labels (Provided)

- The unit labels are not attached to the K3MA-J. Select the desired labels from the provided sheet.

V	A	V	A	%	J	Pa	Ω
s	/	N	m	W	°C	m ³	k
°F	g	min	mm	rpm			
VA	mV	mA	Hz				
m/min	OMRON						
OUT	OUT						

Note: For scales and gauges, use the unit labels that are specified by the relevant laws or regulations.

Wiring Precautions

- Use crimp terminals.
- Tighten the terminal screws to a torque of approximately 0.5 N·m.
- To avoid the influence of noise, route signal lines and power lines separately.

Wiring

- Use the following M3 crimp terminals.

Precautions

⚠ WARNING
Do not touch any of the terminals while the power is being supplied. Doing so may result in electric shock.

⚠ Caution
Do not disassemble the product or touch the internal components of the product while the power is being supplied. Doing so may result in electric shock.

⚠ Caution
Do not allow metal objects or wire cuttings to enter the product. Doing so may result in electric shock, fire, or malfunction.

⚠ Caution
Perform correct settings for the product according to the control application. Failure to do so may cause unexpected operation, resulting in damage to the product or injury.

⚠ Caution
Take safety measures, such as installing a separate monitoring system, to ensure safety even if the product fails. Product failure may prevent comparative outputs from being generated, resulting in serious accidents.

Observe the following precautions to ensure safety.

1. Maintain the power supply voltage within the range specified in the specifications.
2. Maintain the load within the ratings specified in the specifications.
3. Check each terminal for correct number and polarity before connecting it. Incorrect or reverse connections may damage or burn out internal components in the product.
4. Tighten the terminal screws securely. The recommended tightening torque is 0.43 to 0.58 N·m. Loose screws may cause fire or malfunction.
5. Do not connect anything to unused terminals.
6. Provide a switch or circuit breaker so that operators can easily turn OFF the power supply when necessary. Also provide appropriate indications of such devices.
7. Do not attempt to disassemble, repair, or modify the product.
8. Do not use the product where flammable or combustible gases are present.

Application

General Precautions

1. Do not use the product in the following locations:
 - Locations subject to direct radiant heat from heating equipment.
 - Locations subject to exposure to water, oil, or chemicals.
 - Locations subject to direct sunlight.
 - Locations subject to dust or corrosive gases (particularly sulfuric gas or ammonia gas).
 - Locations subject to severe changes in temperature.
 - Locations subject to icing or condensation.
 - Locations subject to shock or vibration.
2. Do not block heat dissipation around the product, i.e., provide sufficient space for heat dissipation.
3. Ensure that the rated voltage is reached within two seconds after the power is turned ON.
4. Conduct aging for 15 minutes min. after power is turned ON for correct measurement.

5. Do not touch the slit sections or terminals while the power is being supplied to prevent the product from being affected by static electricity.
6. Do not lay heavy objects on the product during use or storage. Doing so may deform or deteriorate the product.
7. Do not use paint thinner for cleaning. Use commercially available alcohol.

Mounting

- Mount the product to a panel that is 1 to 8 mm thick.
- Install the product in a horizontal position.
- Use crimp terminals that match screw sizes.

Noise Prevention

- Install the product as far as possible from devices that generate strong, high-frequency fields (such as high-frequency welders or sewing machines) or surges.
- Install surge absorbers or noise filters on nearby devices that generate noise (particularly, motors, transformers, solenoids, magnet coils, and other devices that have a high inductance component).

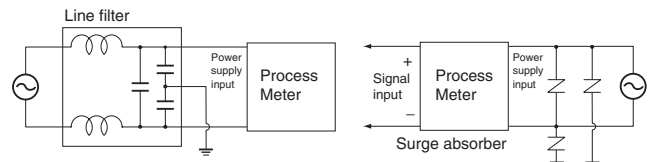

- To prevent inductive noise, separate the terminal block wiring for the product from high-voltage or high-current power lines. Do not route the wiring for the product in parallel with or tie it in a bundle with power lines. Take the following countermeasures against inductive noise in input lines.

Analog Signal Inputs

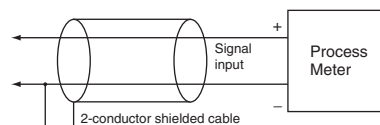

- When using a noise filter for the power supply, check for the voltage and current and install it as close as possible to the Process Meter.
- Do not install the product near radios, television sets, or wireless devices. Doing so may cause reception interference.

Increasing Service Life

- Do not use the product in locations where the temperature or humidity exceeds the ratings or where condensation may occur. When installing the product in a panel, be sure that the temperature around the product (not the temperature around the panel) does not exceed the ratings. The product service life depends on the ambient temperature. The higher the ambient temperature, the shorter the service life. To extend the product service life, lower the temperature inside the Process Meter.
- Use and store the product within the temperature and humidity ranges given in the specifications. When gang-mounting Process Meters or arranging them vertically, heat generated by the Process Meters will cause the internal temperature to rise, reducing the service life. In such cases, consider forced cooling methods, such as using a fan to circulate air around the Process Meters. Do not, however, allow only the terminals to be cooled. Doing so will increase measurement error.
- The life of the output relays is greatly affected by the switching capacity and switching conditions. Use these relays within their rated load and electrical life. The contacts may fuse or burn if they are used past their electrical life.

Operating Procedures

■ Levels

“Level” refers to a grouping of parameters. The following table lists the operations that are possible in each of the levels, and the diagram tells how to move between levels. There are some parameters that are not displayed for certain models.

Level name	Function	Measurement
Protect	Setting lockouts.	Continue
Operation	Displaying current values, setting/clearing forced-zero function, and setting OUT 1/2 values.	Continue
Initial setting	Making initial settings of input type, scaling, output operating action, and other parameters.	Stopped
Advanced-function setting	Setting average processing, display color settings, and other advanced-function parameters.	Stopped

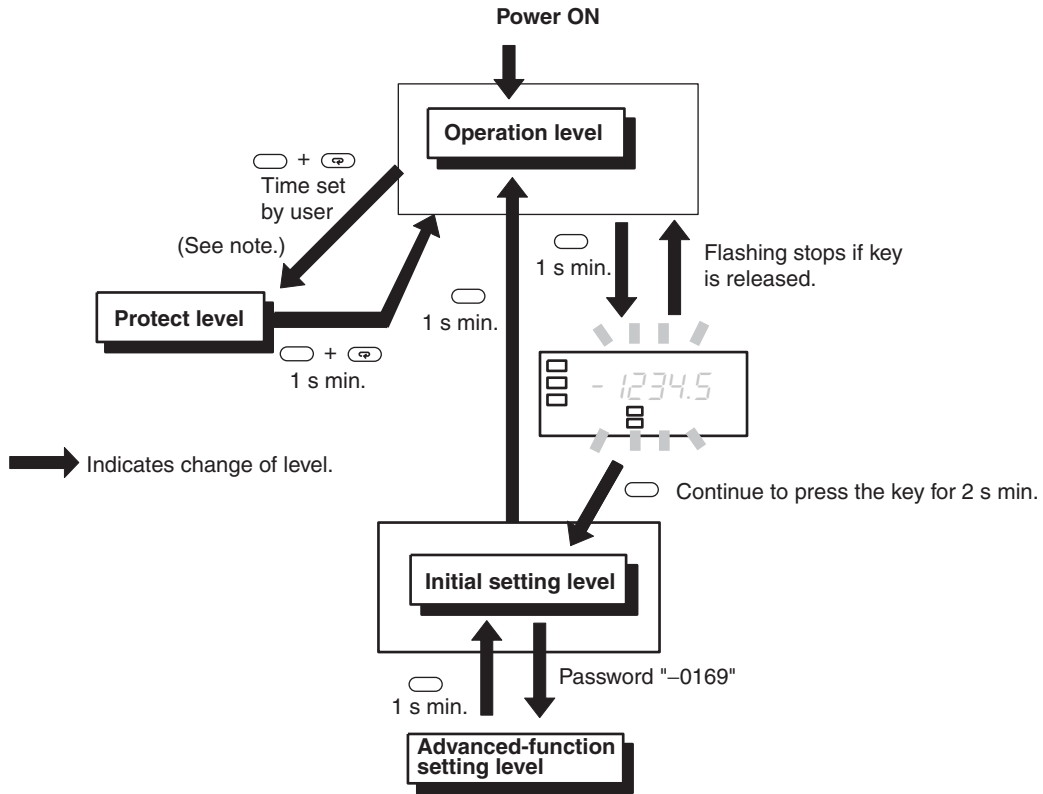

Note: The move-to-protect-level time can be set in the advanced-function setting level.

Digital panel indicators

Parameters

- Note:**
1. Some parameters are not displayed for certain models.
 2. The K3MA-J will stop measurement if the level is changed to the initial setting level or the advanced-function setting level.
 3. If the input range is changed, some parameters are set to default values. Therefore, set the input range first.
 4. Settings displayed in reversed colors are defaults.

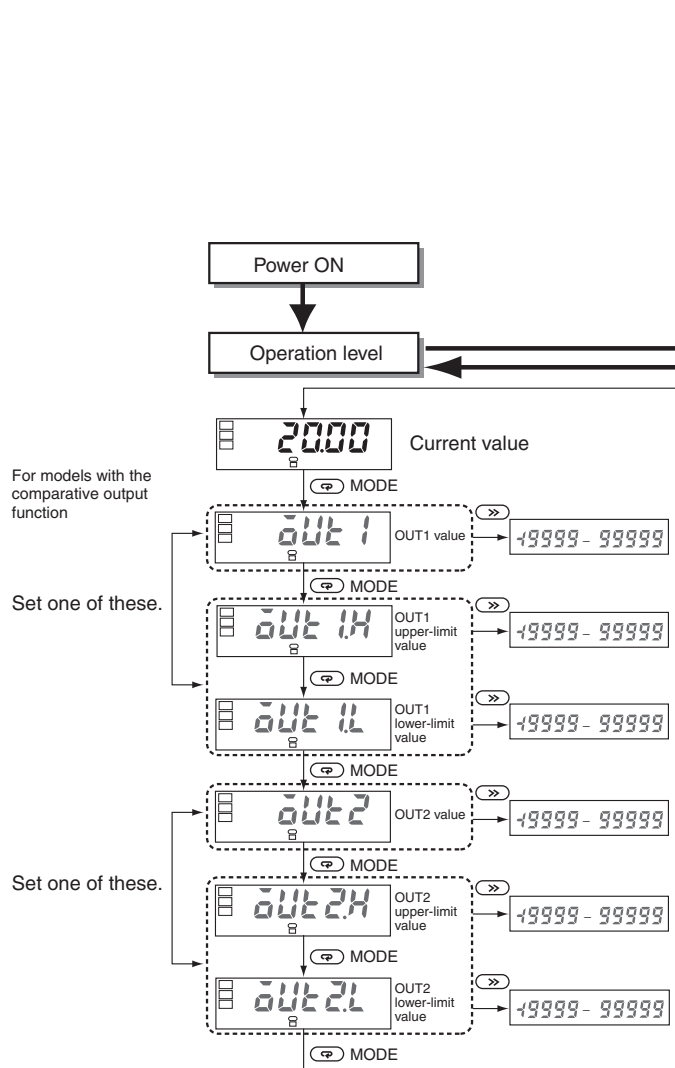

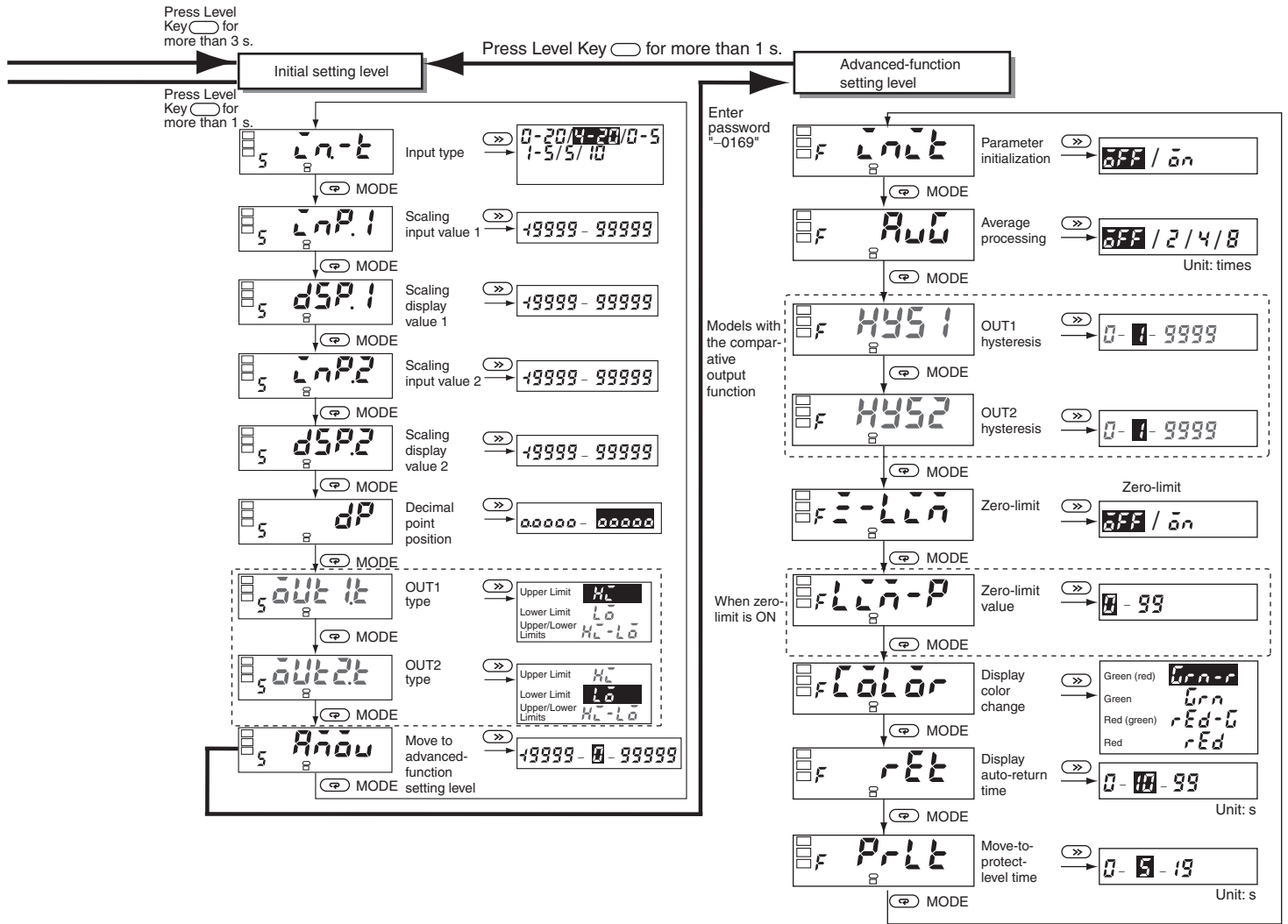

Digital panel indicators

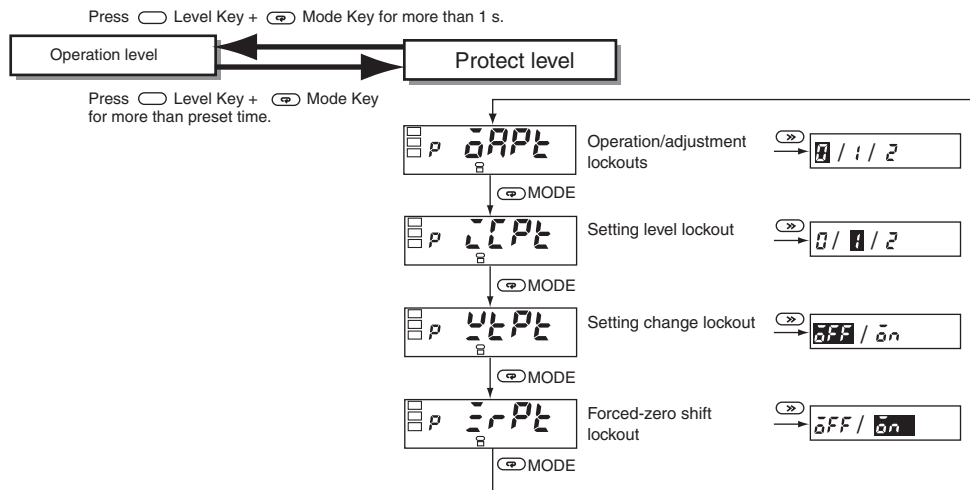

Operation/Adjustment Lockouts

Restricts key operations for operation level and adjustment level.

Parameter	Setting	Operation level	
		Current value display	Set value display
oapt	0	Allowed	Allowed
	1	Allowed	Allowed
	2	Allowed	Prohibited

- Initial setting is 0.
- This cannot be displayed on models not equipped with the comparative output function.

Setting Level Lockout

Restricts shifting to initial setting level or advanced-function setting level.

Parameter	Setting	Shift to initial setting level	Shift to advanced-function setting level
		icpt	0
	1	Allowed	Prohibited
	2	Prohibited	Prohibited

Setting Change Lockout

Restricts setting changes by key operation. When this lockout is set, it is no longer possible to shift to a setting change mode.

Parameter	Setting	Setting change by key operation
wtpt	off	Allowed
	on	Prohibited

However, all protect level parameters can still be changed.

Forced-zero Lockout

Restricts the setting or release of a forced-zero by front-panel key operation.

Parameter	Setting	Setting/release of forced-zero by key operation
=rpt	off	Allowed
	on	Prohibited

Initial Settings

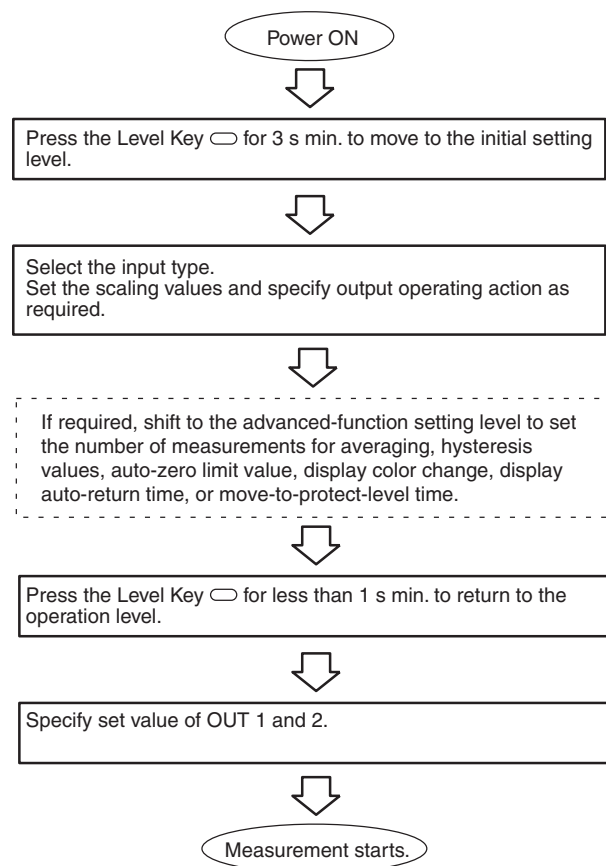

Setting Example

Initial Settings

The settings for the following example are shown here.

Example: Tank pressure display

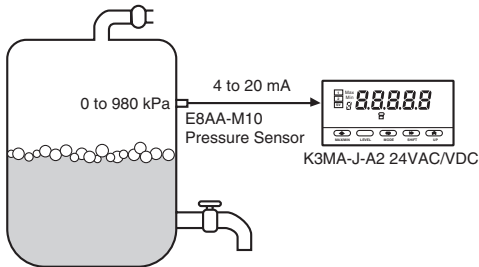

Here, the pressure inside the tank is to be displayed in units of 0.1 kPa.

- Pressure Sensor: E8AA-M10
Measuring range: 0 to 980 kPa, output 4 to 20 mA

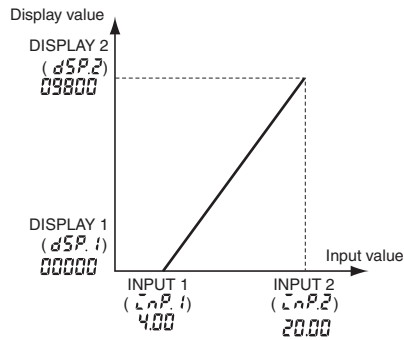

1. Set the K3MA-J input type to the 4 to 20 mA input range.
Parameter: $\bar{I}n-t$ (input type), Setting value: 4-20
2. Set the display values for the corresponding input values.
Set the scaling as shown below for the following correspondence:
input 4 mA-->display 0.0, input 20 mA-->display 980.0
ParameterSetting value
 $\bar{I}nP.1$ (scaling input value 1)4.00
 $dSP.1$ (scaling display value 1)00000
 $\bar{I}nP.2$ (scaling input value 2)20.00
 $dSP.2$ (scaling display value 2)9800
 dP (decimal point position)0000.0

Note: The decimal point position here refers to the position in the number after scaling. When setting the scaling display value, it is necessary to consider the number of digits to be displayed past the decimal point.

Troubleshooting

When an error occurs, error details will be displayed on the main indicator. Confirm the error from the main indicator and take the appropriate countermeasures.

Level display	Main indicator	Error contents	Countermeasures
Not lit	e111	RAM memory error	Repair is necessary. Consult your OMRON sales representative.
5	e111	EEPROM memory error	When this error is displayed, press the Level Key for 3 seconds, and the settings will be restored to the factory settings. If the error cannot be recovered, repair is necessary. Consult your OMRON sales representative.
Not lit	Flashes <i>S.Err</i>	You will see this indication when turning ON the product the first time after purchase. This is because the input signal value is 0 mA at that time even though the range is factory set to 4 to 20 mA. Input error	At the initial setting level, set the input type and other parameters according to your application. Promptly change the input voltage/current to a value that falls within the measurement range. If the error cannot be recovered, repair is necessary. Consult your OMRON sales representative.
Not lit	Flashes <i>99999</i>	The scaling display value exceeds 99999.	Promptly change the input to a value that falls within the specified range. The scaling value may be inappropriate. Review the scaling value at the initial setting level.
Not lit	Flashes <i>-19999</i>	The scaling display value is lower than -19999.	Promptly change the input to a value that falls within the specified range. The scaling value may be inappropriate. Review the scaling value at the initial setting level.

Warranty and Limitations of Liability

■ WARRANTY

OMRON's exclusive warranty is that the products are free from defects in materials and workmanship for a period of one year (or other period if specified) from date of sale by OMRON.

OMRON MAKES NO WARRANTY OR REPRESENTATION, EXPRESS OR IMPLIED, REGARDING NON-INFRINGEMENT, MERCHANTABILITY, OR FITNESS FOR PARTICULAR PURPOSE OF THE PRODUCTS. ANY BUYER OR USER ACKNOWLEDGES THAT THE BUYER OR USER ALONE HAS DETERMINED THAT THE PRODUCTS WILL SUITABLY MEET THE REQUIREMENTS OF THEIR INTENDED USE. OMRON DISCLAIMS ALL OTHER WARRANTIES, EXPRESS OR IMPLIED.

■ LIMITATIONS OF LIABILITY

OMRON SHALL NOT BE RESPONSIBLE FOR SPECIAL, INDIRECT, OR CONSEQUENTIAL DAMAGES, LOSS OF PROFITS, OR COMMERCIAL LOSS IN ANY WAY CONNECTED WITH THE PRODUCTS, WHETHER SUCH CLAIM IS BASED ON CONTRACT, WARRANTY, NEGLIGENCE, OR STRICT LIABILITY.

In no event shall the responsibility of OMRON for any act exceed the individual price of the product on which liability is asserted.

IN NO EVENT SHALL OMRON BE RESPONSIBLE FOR WARRANTY, REPAIR, OR OTHER CLAIMS REGARDING THE PRODUCTS UNLESS OMRON'S ANALYSIS CONFIRMS THAT THE PRODUCTS WERE PROPERLY HANDLED, STORED, INSTALLED, AND MAINTAINED AND NOT SUBJECT TO CONTAMINATION, ABUSE, MISUSE, OR INAPPROPRIATE MODIFICATION OR REPAIR.

Application Considerations

■ SUITABILITY FOR USE

OMRON shall not be responsible for conformity with any standards, codes, or regulations that apply to the combination of products in the customer's application or use of the products.

At the customer's request, OMRON will provide applicable third party certification documents identifying ratings and limitations of use that apply to the products. This information by itself is not sufficient for a complete determination of the suitability of the products in combination with the end product, machine, system, or other application or use.

The following are some examples of applications for which particular attention must be given. This is not intended to be an exhaustive list of all possible uses of the products, nor is it intended to imply that the uses listed may be suitable for the products.

- Outdoor use, uses involving potential chemical contamination or electrical interference, or conditions or uses not described in this catalog.
- Nuclear energy control systems, combustion systems, railroad systems, aviation systems, medical equipment, amusement machines, vehicles, safety equipment, and installations subject to separate industry or government regulations.
- Systems, machines, and equipment that could present a risk to life or property.

Please know and observe all prohibitions of use applicable to the products.

NEVER USE THE PRODUCTS FOR AN APPLICATION INVOLVING SERIOUS RISK TO LIFE OR PROPERTY WITHOUT ENSURING THAT THE SYSTEM AS A WHOLE HAS BEEN DESIGNED TO ADDRESS THE RISKS, AND THAT THE OMRON PRODUCTS ARE PROPERLY RATED AND INSTALLED FOR THE INTENDED USE WITHIN THE OVERALL EQUIPMENT OR SYSTEM.

ALL DIMENSIONS SHOWN ARE IN MILLIMETERS.

To convert millimeters into inches, multiply by 0.03937. To convert grams into ounces, multiply by 0.03527.