

Switch Mode Power Supply S82K

Ultimate DIN-rail-mounting Power Supply with a Power Range of 3 to 100 W

- EMI: EN 61204-3 class B
- Input: 85 to 264 VAC (except 90-W and 100-W models)
- Safety standards: UL 60950-1/508, cUL: C22.2, cUR: No. 60950-1/14, Class 2 (UL, CSA), EN 60950-1 (=VDE 0805, Teil 1)
- Undervoltage alarm indication available for standard models.

Note: Refer to "Safety Precautions" on page B-77.



Model Number Structure

Model Number Legend

Note: Not all combinations are possible. Please refer to the list of models in "Ordering Information" on page B-65.

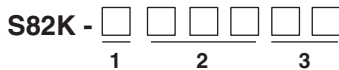

1. Power Factor Correction

None: No
P: Yes

2. Power Ratings

003: 3 W 050: 50 W
007: 7.5 W 090: 90 W
015: 15 W 100: 100 W
030: 30 W

3. Output Voltage

05: +5 VDC 24: +24 VDC
12: +12 VDC 27: ±12 VDC
15: +15 VDC 28: ±15 VDC

Ordering Information

List of Models

Note: For details on normal stock models, contact your nearest OMRON representative.

Power ratings	Output voltage	Output current	Function Configuration			Models	
			Output	Undervoltage alarm indicator/output	PFC		
3 W	5 V	0.6 A	Single output	Yes	No	S82K-00305	
	12 V	0.25 A				S82K-00312	
	15 V	0.2 A				S82K-00315	
	24 V	0.13 A				S82K-00324	
7.5 W	5 V	1.5 A	Single output	Yes	No	S82K-00705	
	12 V	0.6 A				S82K-00712	
	15 V	0.5 A				S82K-00715	
	24 V	0.3 A				S82K-00724	
	±12 V	0.3 A/0.2 A				Dual output	S82K-00727
	±15 V	0.2 A/0.2 A					S82K-00728
15 W	5 V	2.5 A	Single output	Yes	No	S82K-01505	
	12 V	1.2 A				S82K-01512	
	24 V	0.6 A				S82K-01524	
30 W	5 V	5.0 A	Single output	Yes	No	S82K-03005 (See note 1.)	
	12 V	2.5 A				S82K-03012	
	24 V	1.3 A				S82K-03024	
50 W	24 V	2.1 A	Single output	Yes	No	S82K-05024	
90 W	24 V	3.75 A				S82K-09024	
100 W	24 V	4.2 A (See note 2.)				S82K-P09024	
						S82K-10024	
					Yes	S82K-P10024	

Note: 1. The output capacity of the S82K-03005 is 25 W.
2. The output current during parallel operation is 3.78 A.

Specifications

■ Ratings/Characteristics

Power ratings (See note 1.)		S82K						
		Single output		Dual output	Single output			
Item		3 W	7.5 W	7.5 W	15 W	30 W		
Efficiency (typical)		60% min. (Varies depending on specifications)		64% min. (Varies depending on specifications)		66% min. (Varies depending on specifications)		
Input (See note 2.)	Voltage	100 to 240 VAC (85 to 264 VAC)						
	AC							
	DC	90 to 350 VDC				Not possible		
	Frequency	50/60 Hz (47 to 450 Hz)						
	Current (See note 3.)	100-V input	0.15 A max.		0.25 A max.		0.45 A max.	0.9 A max.
		200-V input					0.25 A max.	0.6 A max.
	Power Factor	---						
	Harmonic current emissions	---						
	Leakage current (See note 3.)	100-V input	0.5 mA max.					
		200-V input	1 mA max.					
Inrush current (See note 3.)	100-V input	15 A max. (for cold start at 25°C)				25 A max. (for cold start at 25°C)		
	200-V input	30 A max. (for cold start at 25°C)				50 A max. (for cold start at 25°C)		
Noise filter	Yes							
Output (See note 4.)	Voltage Adjustment Range	±10% (with V. ADJ) (See note 5.)		Not possible (See note 6.)	±10% (with V. ADJ) (–10% to 15% for S82K-03012/-03024) (See note 5.)			
	Ripple (See note 3.)	2% (p-p) max.						
	Input variation influence	0.5% max. (at 85 to 264 VAC input, 100% load)						
	Load variation influence (rated input voltage)	1.5% max. (0 to 100% load)			+V: 1.5% max. –V: 3% max. (0 to 100% load)	1.5% max. (0 to 100% load)		
	Temperature variation influence (See note 3.)	0.05%/°C max.						
	Start up time	100 ms max. (up to 90% of output voltage at rated input and output)						
Hold time (See note 3.)	20 ms min.							
Additional functions	Overload protection (See note 7.)	105% to 160% of rated load current (105% to 250% of rated load current for dual output models), gradual current/voltage drop, automatic reset (See note 8.)				105% to 160% of rated load current, gradual current increase, voltage drop intermittent operation, automatic reset		
	Overvoltage protection	No						
	Undervoltage alarm indication	Yes (color: red)						
	Undervoltage alarm output	No						
	Parallel operation	No						
Other	Operating ambient temperature	Refer to the derating curve in Engineering Data. (with no icing or condensation)						
	Storage temperature	–25 to 65°C (with no icing or condensation)						
	Operating ambient humidity	25°C to 85% (Storage humidity: 25% to 90%)						
	Dielectric strength	3.0 kVAC for 1 min. (between all inputs and all outputs)						
		2.0 kVAC for 1 min. (between all inputs and PE terminals)						
		1.0 kVAC for 1 min. (between all outputs and PE terminals)						
	Detection current	10 mA			20 mA			
	Insulation resistance	100 MΩ min. (between all outputs and all inputs, PE terminals) at 500 VDC						
	Vibration resistance	10 to 55 Hz, 0.375-mm single amplitude for 2 h each in X, Y, and Z directions						
	Shock resistance	300 m/s ² , 3 times each in ±X, ±Y, ±Z directions						
	Output indicator	Yes (color: green)						
	EMI	Conducted Emissions	Conforms to EN61204-3 EN55011 Class B and based on FCC Class B					
		Radiated Emissions	Conforms to EN61204-3 EN55011 Class B					
	EMS	Conforms to EN61204-3 High severity levels						
Approved standards	UL: UL508 (Listing), 60950-1 Class 2 (excluding Dual output models) CSA: cUL: C22.2 No.14, cUR: No. 60950-1 Class 2 (excluding Dual output models) EN/VDE: EN50178 (VDE=0160), EN60950-1 (=VDE0805 Teil 1) Based on VE0106/P100							
Weight	150 g max.			260 g max.		380 g max.		

- Note:**
- When a load is connected that has a built-in DC-DC converter, the overload protection may operate at startup and the power supply may not start. Refer to the *Overload Protection* section on page B-72 for details.
 - Use with DC voltage input is beyond the conditions of approval or conformance to applicable safety standards. (DC input possible with 15 W max. Use the 7.5-W single-output models under the load of 90% max. if the voltage range is between 90 and 110 VDC. Do not use the Inverter output for the Power supply. Inverters with an output frequency of 50/60 Hz are available, but the rise in the internal temperature of the Power Supply may result in ignition or burning.
 - Defined with a 100% load and the rated input voltage (100 or 200 VAC.)
 - The output specification is defined at the power supply output terminals.
 - If the V. ADJ adjuster is turned, the voltage will increase by more than +10% of the voltage adjustment range. (+15% for S82K-03012/-03024) When adjusting the output voltage, confirm the actual output voltage from the Power Supply and be sure that the load is not damaged.
 - The settings for the output voltage must be within the following range:
+V: ±1% of the rated value
–V: ±5% of the rated value
 - Refer to the *Overload Protection* section on page B-72 for details.
 - When using the 7.5-W single-output models within the input voltage range between 90 and 110 VDC, the protection function will operate at a current of 95% to 160% of the rated load current.

Power ratings (See note 1.)		S82K		S82K-P			
		Single output		90 W	100 W		
Item		50 W	90 W	100 W	90 W	100 W	
Efficiency (typical)		80% min. (Varies depending on specifications)					
Input (See note 2.)	Voltage	100 to 240 VAC (85 to 264 VAC) 100 V (85 to 132 VAC)/200 V (170 to 264 VAC) Selectable					
	AC	Not possible					
	DC	Not possible					
	Frequency	50/60 Hz (47 to 450 Hz)			50/60 Hz (47 to 63 Hz)		
	Current (See note 3.)	100-V input	1.3 A max.	2.5 A max.			
		200-V input	0.8 A max.	1.5 A max.			
	Power Factor	---			0.7 min. (at 200 VAC input, at rated output), 100 V: unlimited		
	Harmonic current emissions	---			Conforms to EN6100-3-2 (200-V only)		
	Leakage current (See note 3.)	100-V input	0.5 mA max.				
		200-V input	1 mA max.				
Inrush current (See note 3.)	100-V input	25 A max. (for cold start at 25°C)					
	200-V input	50 A max. (for cold start at 25°C)					
Noise filter	Yes						
Output (See note 4.)	Voltage Adjustment Range	±10% (with V. ADJ) (-10% to 15% for S82K-05024) (See Note 5.)			±10% (with V. ADJ) (See note 5.)		
	Ripple (See note 3.)	2% (p-p) max.					
	Input variation influence	0.5% max. (at 85 to 264 VAC input, 100% load)	0.5% max. (at 85 to 132 VAC input /170 to 264 VAC input, 100% load)				
	Load variation influence (rated input voltage)	1.5% max. (0 to 100% load)					
	Temperature variation influence (See note 3.)	0.05%/°C max.					
	Start up time	100 ms max. (up to 90% of output voltage at rated input and output)	200 ms max.				
	Hold time (See note 3.)	20 ms min.					
	Additional functions	Overload protection (See note 6.)	105% to 160% of rated load current, gradual current increase, voltage drop intermittent operation, automatic reset	105% to 160% of rated load current, inverted L drop, automatic reset (See note 7.)			
Overvoltage protection		No					
Undervoltage alarm indication		Yes (color: red)					
Undervoltage alarm output		No	Yes			No	
Parallel operation		No	Yes (up to 2 units.)		No	Yes (up to 2 units.) (See note 8.)	
Other	Operating ambient temperature	Refer to the derating curve in Engineering Data. (with no icing or condensation)					
	Storage temperature	-25 to 65°C (with no icing or condensation)					
	Operating ambient humidity	25°C to 85% (Storage humidity: 25% to 90%)					
	Dielectric strength	3.0 kVAC for 1 min. (between all inputs and all outputs)					
		2.0 kVAC for 1 min. (between all inputs and PE terminals)					
	Detection current	1.0 kVAC for 1 min. (between all outputs and PE terminals)					
		20 mA					
	Insulation resistance	100 MΩ min. (between all outputs and all inputs, PE terminals) at 500 VDC					
	Vibration resistance	10 to 55 Hz, 0.375-mm single amplitude for 2 h each in X, Y, and Z directions					
	Shock resistance	300 m/s ² , 3 times each in ±X, ±Y, ±Z directions			150 m/s ² , 3 times each in ±X, ±Y, ±Z directions		
Output indicator	Yes (color: green)						
EMI	Conducted Emissions	Conforms to EN61204-3 EN55011 Class B and based on FCC Class B		Conforms to EN61204-3 EN55011 Class B and based on FCC Class A			
	Radiated Emissions	Conforms to EN61204-3 EN55011 Class B					
EMS	Conforms to EN61204-3 High severity levels						
Approved standards	UL: UL508 (Listing), 60950-1 Class 2 (excluding Dual output models) (See note 9.) CSA: cUL: C22.2 No.14, cUR: No. 60950-1 Class 2 (excluding Dual output models) (See note 9.) EN/VDE: EN50178 (VDE=0160), EN60950-1 (=VDE0805 Teil 1) Based on VEO106/P100			UL: UL508 (Listing), Class 2 (per UL 1310) 60950-1 (See note 9.) CSA: cUL: C22.2 No.14, cUR: No. 60950-1 Class 2 (See note 9.) EN/VDE: EN50178 (VDE=0160), EN60950-1 (=VDE0805 Teil 1) According to VDE0106/P100"			
Weight	400 g max.		600 g max.		1000g max.		

- Note:**
- When a load is connected that has a built-in DC-DC converter, the overload protection may operate at startup and the power supply may not start. Refer to the *Overload Protection* section on page B-72 for details.
 - Use with DC voltage input is beyond the conditions of approval or conformance to applicable safety standards. (DC input possible with 15 W max. Use the 7.5-W single-output models under the load of 90% max. if the voltage range is between 90 and 110 VDC. Do not use the Inverter output for the Power supply. Inverters with an output frequency of 50/60 Hz are available, but the rise in the internal temperature of the Power Supply may result in ignition or burning.
 - Defined with a 100% load and the rated input voltage (100 or 200 VAC.)
 - The output specification is defined at the power supply output terminals.
 - If the V. ADJ adjuster is turned, the voltage will increase by more than +10% of the voltage adjustment range. (+15% for S82K-03012/-03024) When adjusting the output voltage, confirm the actual output voltage from the Power Supply and be sure that the load is not damaged.
 - Refer to the *Overload Protection* section on page B-72 for details.
 - When using the 90-W model at an ambient temperature of 25°C or less, the overload protection function will operate at currents from 101% to 111% of the rated output current. When using the 90-W model at an ambient temperature exceeding 25°C, the overload protection function will operate at currents from 92% to 111% of the rated output current.
 - Parallel operation is set with the Parallel/Single Operation Selector Switch.
 - To meet Class-2 requirements with the 100-W, either a fuse or circuit breaker that is UL listed or CSA certified, and rated at 4.2 A max. should be wired in series with the load to be connected to the Power Supply. Only then can the Power Supply output be considered as meeting Class 2.

Connections

■ Block Diagrams

S82K-003□□ (3 W)

S82K-007□□ (7.5 W, Single Output)

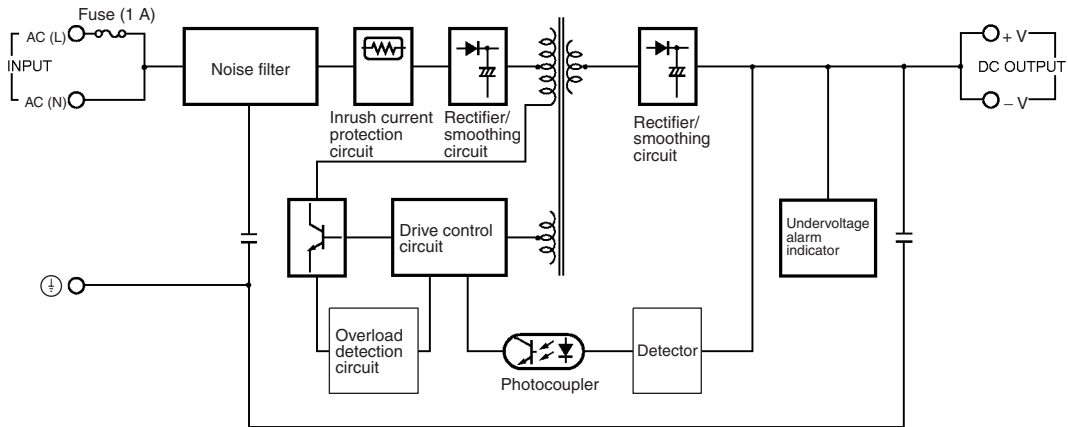

S82K-007□□ (7.5 W, Dual Outputs)

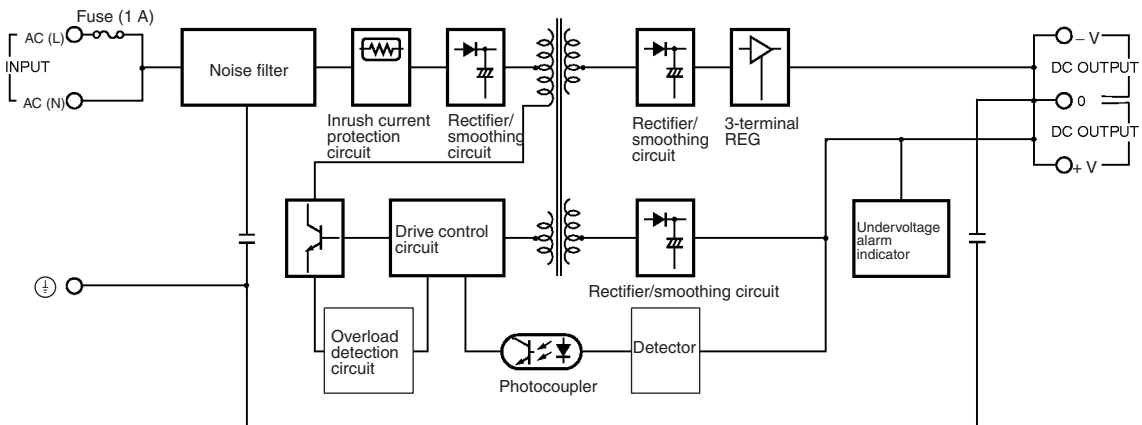

S82K-015□□ (15 W)

S82K-030□□ (30 W)

S82K-05024 (50 W)

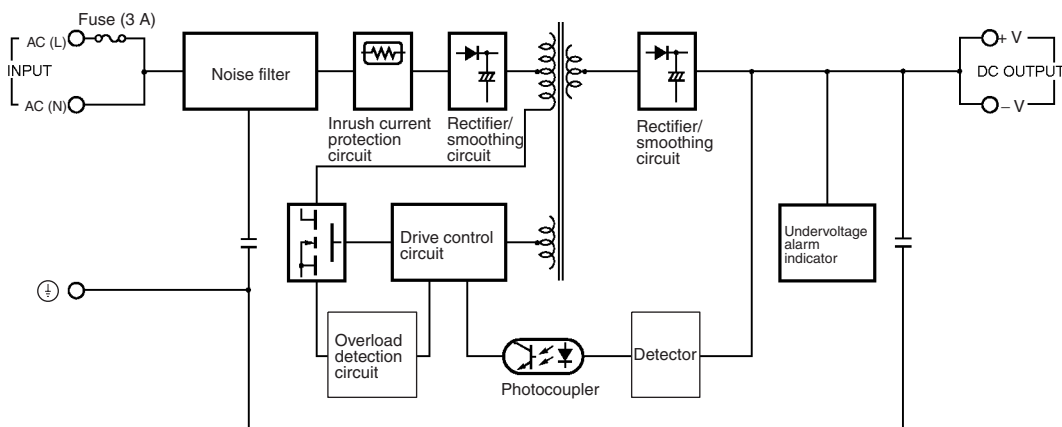

S82K-09024 (90 W)
S82K-10024 (100 W)

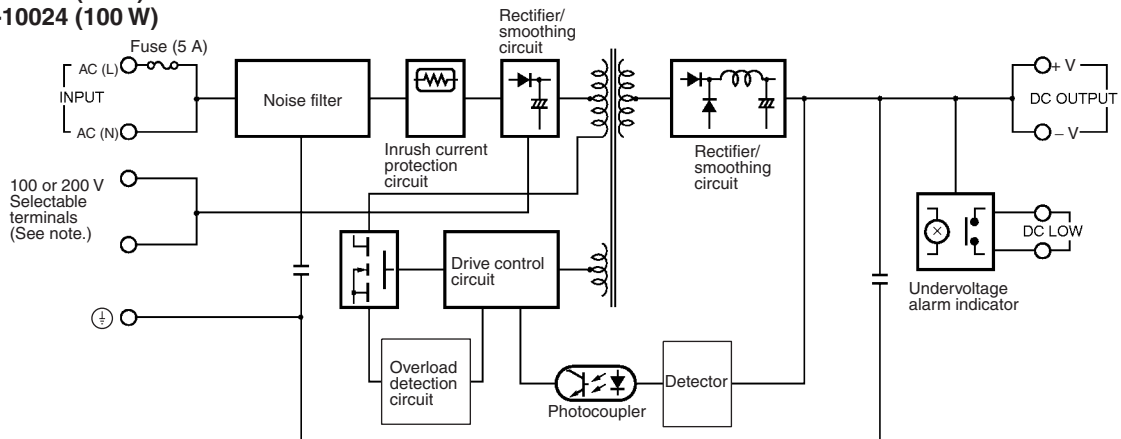

Note: Use the short bar to short-circuit terminals 7 and 8 to select 100 to 120 VAC and remove the short bar to select 200 to 240 VAC.

S82K-P09024 (90 W)
S82K-P10024 (100 W)

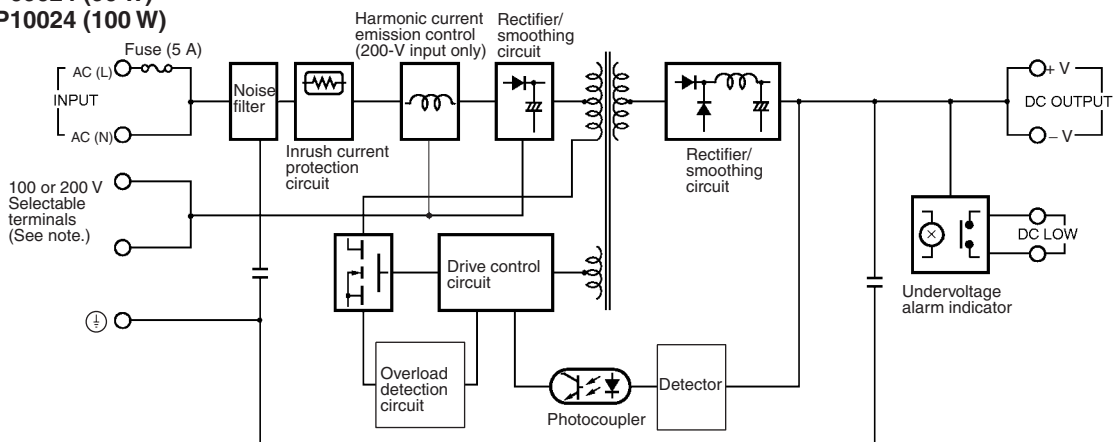

Note: Use the short bar to short-circuit terminals 7 and 8 to select 100 to 120 VAC and remove the short bar to select 200 to 240 VAC.

Construction and Nomenclature

■ Nomenclature

S82K-003□□/S82K-007□□
(Single Output)

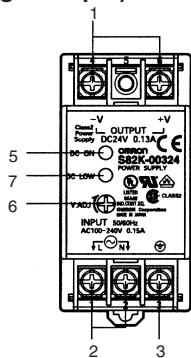

S82K-007□□ (Dual outputs)

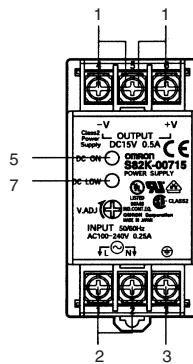

S82K-015□□

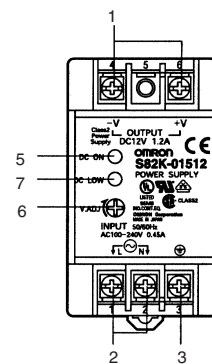

S82K-030□□/S82K-05024

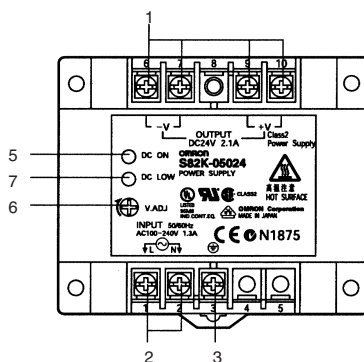

S82K-□09024/S82K-□10024

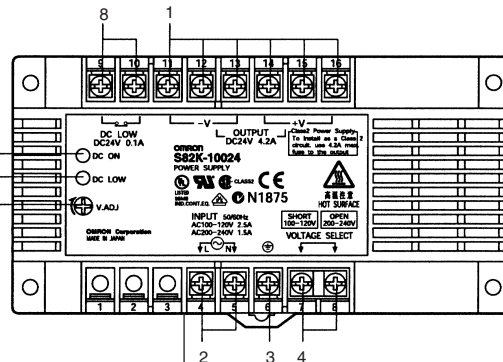

Parallel/Single
Operation Selector
(Only for S82K-
P10024)

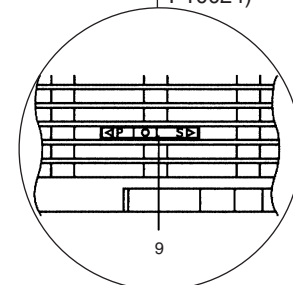

1. **DC Output Terminals:** Connect the load lines to these terminals.
2. **Input Terminals:** Connect the input lines to these terminals.
3. **Protective Earthing Terminals (PE):** Connect a ground line to these terminals.
4. **Input Voltage Selector Terminals (VOLTAGE SELECT):** Selects a 100 V or 200 V input voltage.
5. **Output Indicator (DC ON: green):** Lights while a Direct Current (DC) output is ON.
6. **Output Voltage Adjuster (V.ADJ):** Use to adjust the voltage.
7. **Undervoltage Alarm Indicator Terminal (DC LOW: red):** Lights when there is a drop in the output voltage.
8. **Undervoltage Alarm Output Terminals (DC LOW):** S82K-□09024/-□10024 only.
9. **Parallel/Single Operation Selector:** Set to "PARALLEL" for parallel operation.

Engineering Data

Derating Curve (A: Standard mounting, B: Face-up mounting)

3-/7.5-/15-/30-/50-/100-W Models
Single-Unit Operation

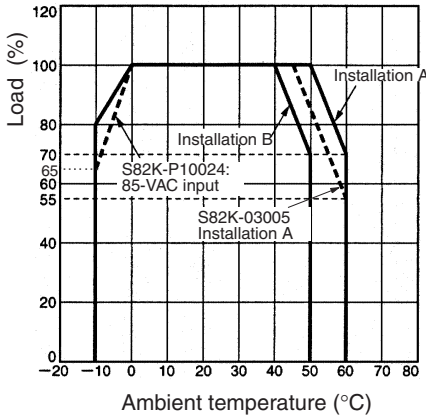

100-W Models without PFC (S82K-10024)
Parallel-Unit Operation

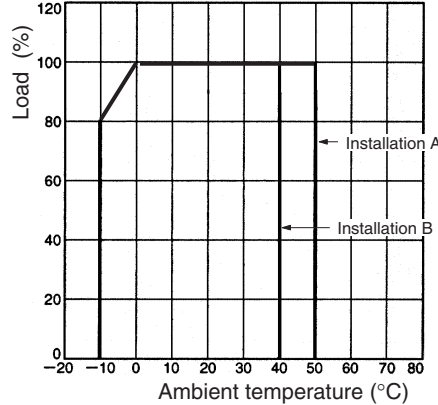

100-W Models with PFC (S82K-P10024)
Parallel-Unit Operation

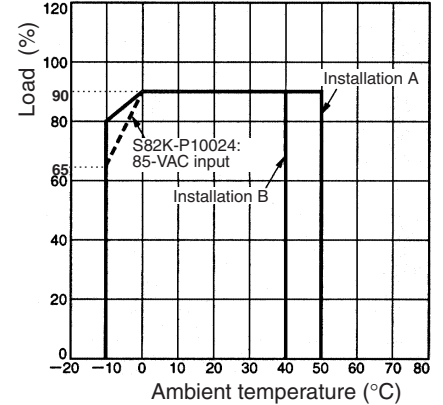

Note: When using the 7.5-W single-output models within the input voltage range between 90 and 110 VDC, the load rate will become 90% or less.

90-W Models
Single-Unit Operation

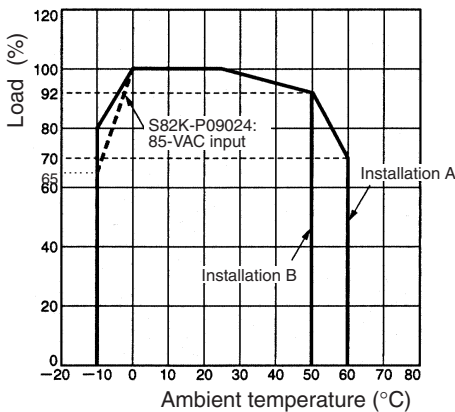

- Note:**
- Note that the derating curve may vary depending on the installation conditions.
 - Multiple units cannot be installed in a configuration where they are lined up vertically.
 - Use the 7.5-W single-output models under the load of 90% max. if the voltage range is between 90 and 110 VDC.
 - The cold-start time will be longer when using S82K-P09024 or S82K-P10024 with 85-VAC input.

Mounting

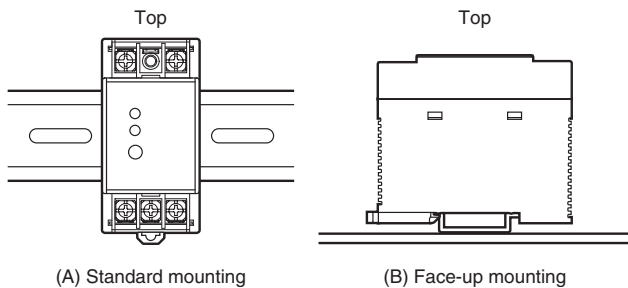

Note: Installations other than (A) and (B) are not possible.

■ Overload Protection

The Power Supply is provided with an overload protection function that protects the Power Supply from possible damage by overcurrent. When the output current rises above 105% min. of the rated current, the protection function is triggered, automatically decreasing the output voltage. When the output current falls within the rated range, the overload protection function is automatically cleared.

3-/7.5/15 W Models

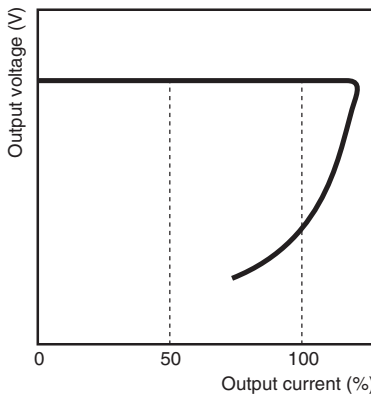

30-/50 W Models

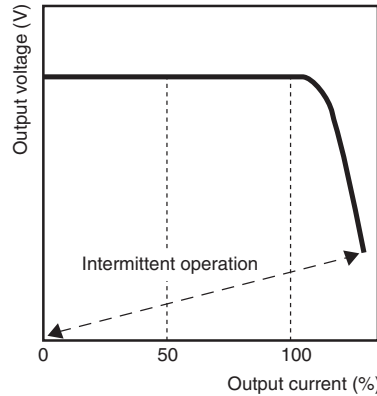

90-/100 W Models

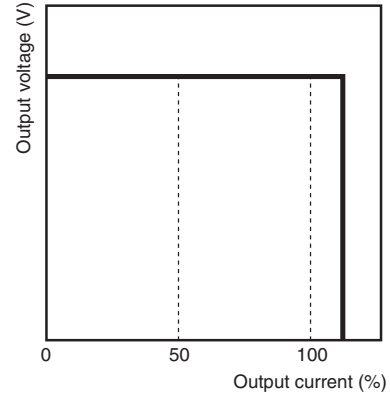

- Note:**
1. When connecting a load that has a built-in DC-DC converter, the overcurrent protection function may operate during start-up, thus preventing the Power Supply from starting.
 2. Internal parts may occasionally deteriorate or be damaged if a short-circuited or other overcurrent state continues during operation.
 3. When using the 7.5-W single-output models within the input voltage range between 90 and 110 VDC, the overload protection function will operate at currents from 95% to 160% of the rated output current.
 4. When using the 90-W model at an ambient temperature of 25°C or less, the overload protection function will operate at currents from 101% to 111% of the rated output current. When using the 90-W model at an ambient temperature exceeding 25°C, the overload protection function will operate at currents from 92% to 111% of the rated output current.
 5. When using the 100-W model with PFC in parallel operation, operation is limited to a load ratio of 90% to 100% of the rated output current at 4.2 A.

When Using ± Output Models

The +V output detects the total output power (+V output and -V output) to trigger the short-circuit protection against overcurrent. This protection varies depending on the -V output state. The -V output independently triggers the short-circuit protection.

■ Undervoltage Alarm Indicator and Output Function

If the output voltage at the output terminal drops to 75% to 90% of the rated voltage, the red indicator of the S82K (DC LOW indicator) will be lit. In the case of the S82K-□09024/□10024, a voltage drop alarm will be output via the relay available in the models (DC LOW output).

Note: This function detects the voltage at the output terminal of the Power Supply. To check the precise output voltage, measure the voltage at the terminal of the load.

Indicator	Voltage	Operation of □09024/□10024's output (DC LOW output) (See note 2.)
Green: ● DC ON Red: ○ DC LOW	If the voltage at the output terminal is more than 82% of the rated voltage and operation is normal, the green indicator will be lit and the red indicator will not be lit.	
Green: ● DC ON Red: ● DC LOW (See note 1.)	If the voltage at the output terminal drops to below 82% of the rated voltage, the red indicator will be lit. (See note 3.)	
Green: ○ DC ON Red: ○ DC LOW	If the voltage at the output terminal approaches 0 V, both the green and red indicators will not be lit.	

- Note:**
1. The more the voltage at the output terminal drops, the darker both the green and red indicators will be.
 2. The relay contacts have a capacity of 0.1 A at 24 VDC.
 3. The red indicator will actually first light at a voltage between 75% and 90% of the rated voltage.

■ Inrush Current, Startup Time, Hold Time

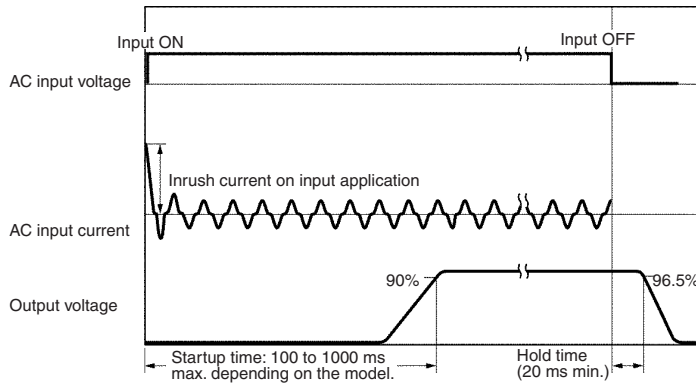

■ Reference Value

Item	Value	Definition
Reliability (MTBF)	135,000 hrs min.	MTBF stands for Mean Time Between Failures, which is calculated according to the probability of accidental device failures, and indicates reliability of devices. Therefore, it does not necessarily represent a life of the product.
Life expectancy	8 yrs. min.	The life expectancy indicates average operating hours under the ambient temperature of 40°C and a load rate of 50%. Normally this is determined by the life expectancy of the built-in aluminum electrolytic capacitor.

Dimensions

Note: All units are in millimeters unless otherwise indicated.

S82K-003□□ (3 W)
S82K-007□□ (7.5 W)

Mounting Brackets (Included)
(Supplied with the Switching Power Supply)
Used when not mounting the Power Supply directly on the DIN-rail.

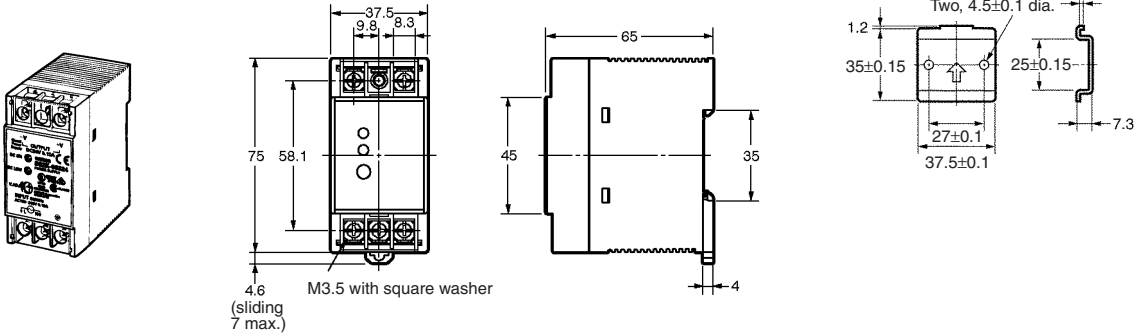

Mounting Holes

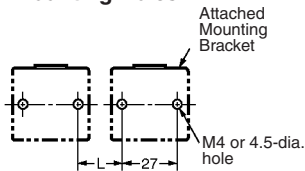

Note: If more than one Power Supply is installed in a row, keep a distance of 20 mm min. (L = 20 mm min.) between each adjacent Power Supply.

S82K-015□□ (15 W)

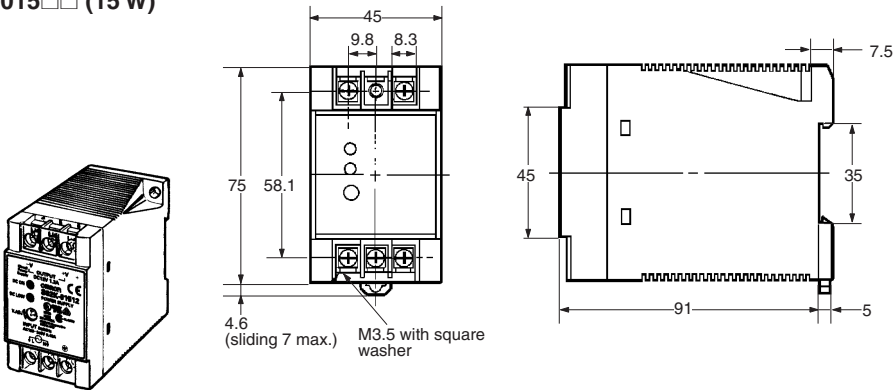

Mounting Holes

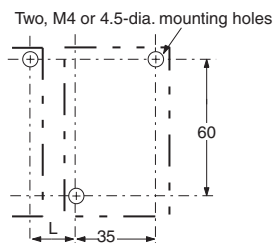

Note: If more than one Power Supply is installed in a row, keep a distance of 20 mm min. (L = 20 mm min.) between each adjacent Power Supply.

S82K-030□□ (30 W)
S82K-05024 (50 W)

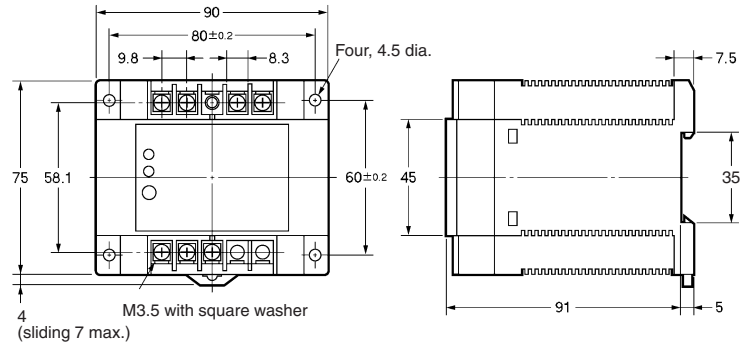
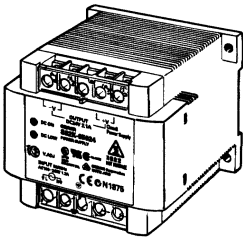

Mounting Holes

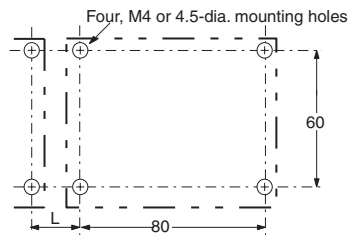

Note: If more than one Power Supply is installed in a row, keep a distance of 20 mm min. (L = 20 mm min.) between each adjacent Power Supply.

S82K-□09024 (90 W)
S82K-□10024 (100 W)

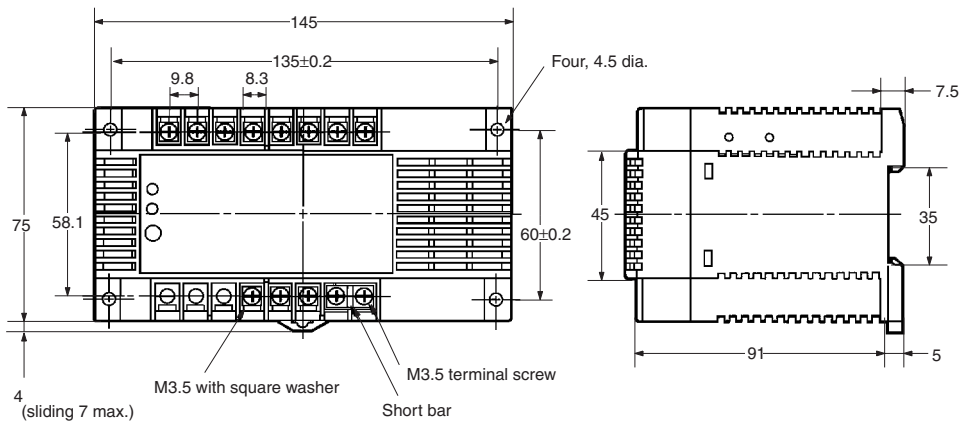
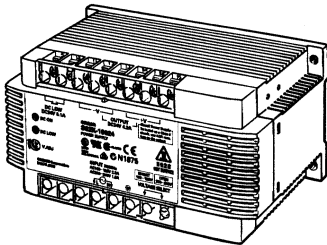

Mounting Holes

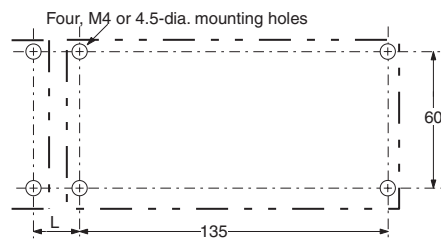

Note: If more than one Power Supply is installed in a row, keep a distance of 20 mm min. (L = 20 mm min.) between each adjacent Power Supply.

■ Accessories

DIN-rail (Order Separately)

PFP-100N/PFP-50N

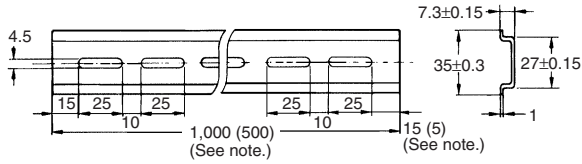
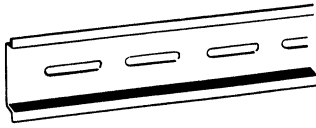

PFP-100N2

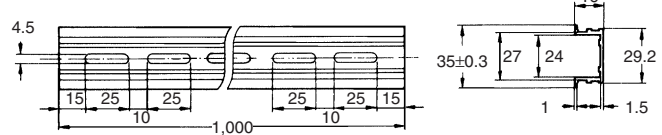
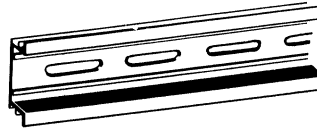

Note: The values shown in parentheses are for the PFP-50N.



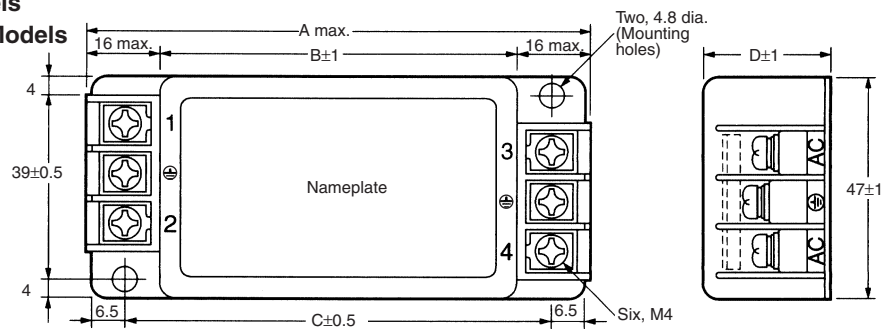
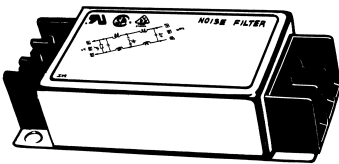

Noise Filter (Order Separately)

S82Y-JF3-N for 3- to 50-W Models

S82Y-JF6-N for 90- and 100-W Models



Safety Precautions

⚠ CAUTION	
Minor electric shock, fire, or Product failure may occasionally occur. Do not disassemble, modify, or repair the Product or touch the interior of the Product.	
Minor burns may occasionally occur. Do not touch the Product while power is being supplied or immediately after power is turned OFF.	
Fire may occasionally occur. Tighten terminal screws to the specified torque of 0.98 N·m.	
Minor injury due to electric shock may occasionally occur. Do not touch the terminals while power is being supplied. Always close the terminal cover after wiring.	
Minor electric shock, fire, or Product failure may occasionally occur. Do not allow any pieces of metal or conductors or any clippings or cuttings resulting from installation work to enter the Product.	

■ Precautions for Safe Use

Mounting

Take adequate measures to ensure proper heat dissipation to increase the long-term reliability of the product.

The Power Supply is designed to radiate heat by means of natural air-flow. Therefore, mount the Power Supply so that air flow takes place around the Power Supply.

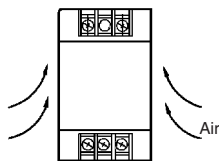

When mounting two or more Power Supplies side-by-side, allow at least 10 mm spacing between them, as shown in the following illustration.

Forced air-cooling is recommended.

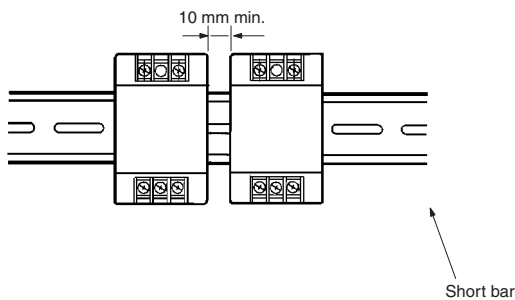

To mount the Power Supply on a DIN-rail, hook portion (A) of the Power Supply to the rail and press the Power Supply toward direction (B).

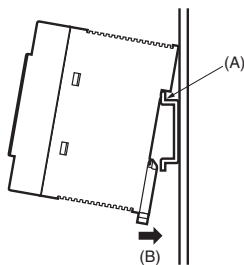

To dismount the Power Supply, pull down portion (C) with a flat-blade screwdriver and pull out the Power Supply.

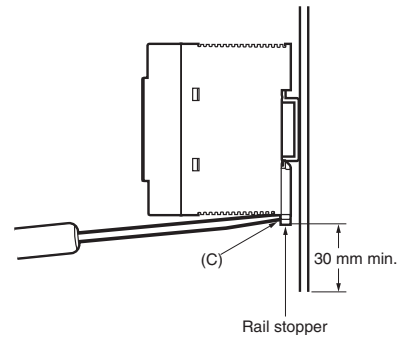

When tightening the terminals, do not tighten the terminal block to a torque greater than 75 N.

Selection of 100 or 200 VAC Input Voltage (S82K-□09024/-□10024)

Select a 100 V or 200 V input by shorting or opening the Input Voltage Selector Terminals, as shown in the following diagram.

(The default setting is 200 V.)

100 V Input

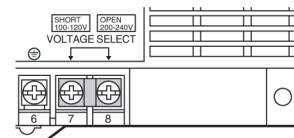

Use the short bar to short-circuit terminals 7 and 8.

200 V Input

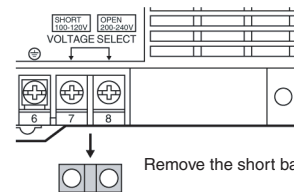

Remove the short bar.

Generating Output Voltage (±)

An output of ± can be generated by using two Power Supplies as shown below, because the Power Supply produces a floating output.

Correct

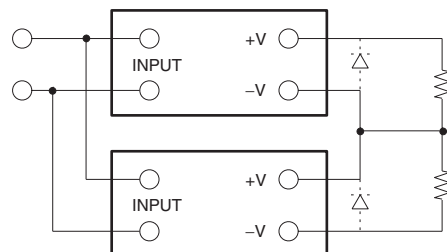

When connecting the Power Supplies in series with an operation amplifier, connect diodes to the output terminals as shown by the dotted lines in the figure. No diodes are required with S82K 90-W/100-W models.

Charging the Battery

If a battery is to be connected as the load, install an overcurrent limiting circuit and an overvoltage protection circuit.

Series Operation

S82K 90-W/100-W models can be operated in series. It must be noted that the + output of the 7.5-W dual output model cannot be connected in series to its - output.

Correct

90-, 100-W Models

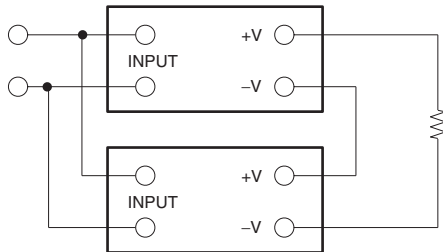

Incorrect

3-, 7.5-, 15-, 30-, 50-W Models

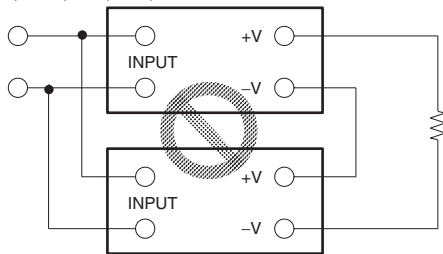

Parallel Operation

S82K 100-W models can be operated in parallel. Perform parallel operation with power supplies satisfying the same specifications.

Correct

100-W Models

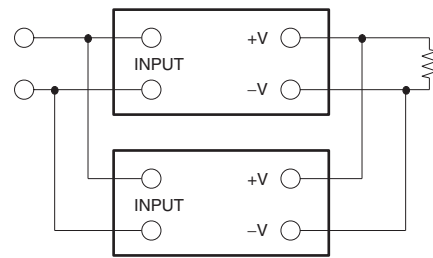

Note: When operating the S82K-P10024 in parallel operation, set the switch to "PARALLEL". In this case, the rated current per S82K-P10024 is 3.78 A.

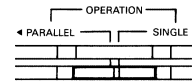

Incorrect

3-, 7.5-, 15-, 30-, 50- and 90-W Models

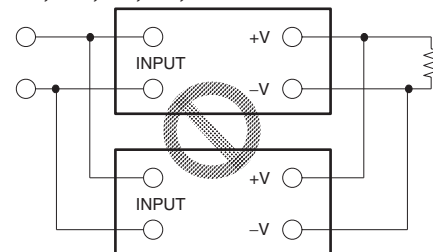

Parallel Operation Precautions

The length and thickness of each wire connected to the load must be the same so that there is no difference in voltage drop value between the load and the output terminals of each Power Supply.

Adjust the output voltage of each Power Supply so that there will be no difference in output voltage between each Power Supply.

Wiring

Do not apply more than 75-N force to the terminal block when tightening it.

Ensure that input and output terminals are wired correctly.

Minimum Output Current (S82K-00727/S82K-00728)

The minimum output current of the S82K-00727 and S82K-00728 is restricted by the output voltage and control method.

Note: All the outputs of the S82K-00727 and S82K-00728 are controlled by the +V output. If the +V output current falls to 10% or less of the rated output, the -V output voltage may drop.

Warranty and Application Considerations

Read and Understand this Catalog

Please read and understand this catalog before purchasing the products. Please consult your OMRON representative if you have any questions or comments.

Warranty and Limitations of Liability

WARRANTY

OMRON's exclusive warranty is that the products are free from defects in materials and workmanship for a period of one year (or other period if specified) from date of sale by OMRON.

OMRON MAKES NO WARRANTY OR REPRESENTATION, EXPRESS OR IMPLIED, REGARDING NON-INFRINGEMENT, MERCHANTABILITY, OR FITNESS FOR PARTICULAR PURPOSE OF THE PRODUCTS. ANY BUYER OR USER ACKNOWLEDGES THAT THE BUYER OR USER ALONE HAS DETERMINED THAT THE PRODUCTS WILL SUITABLY MEET THE REQUIREMENTS OF THEIR INTENDED USE. OMRON DISCLAIMS ALL OTHER WARRANTIES, EXPRESS OR IMPLIED.

LIMITATIONS OF LIABILITY

OMRON SHALL NOT BE RESPONSIBLE FOR SPECIAL, INDIRECT, OR CONSEQUENTIAL DAMAGES, LOSS OF PROFITS, OR COMMERCIAL LOSS IN ANY WAY CONNECTED WITH THE PRODUCTS, WHETHER SUCH CLAIM IS BASED ON CONTRACT, WARRANTY, NEGLIGENCE, OR STRICT LIABILITY.

In no event shall the responsibility of OMRON for any act exceed the individual price of the product on which liability is asserted. IN NO EVENT SHALL OMRON BE RESPONSIBLE FOR WARRANTY, REPAIR, OR OTHER CLAIMS REGARDING THE PRODUCTS UNLESS OMRON'S ANALYSIS CONFIRMS THAT THE PRODUCTS WERE PROPERLY HANDLED, STORED, INSTALLED, AND MAINTAINED AND NOT SUBJECT TO CONTAMINATION, ABUSE, MISUSE, OR INAPPROPRIATE MODIFICATION OR REPAIR.

Application Considerations

SUITABILITY FOR USE

OMRON shall not be responsible for conformity with any standards, codes, or regulations that apply to the combination of products in the customer's application or use of the products.

Take all necessary steps to determine the suitability of the product for the systems, machines, and equipment with which it will be used.

Know and observe all prohibitions of use applicable to this product.

NEVER USE THE PRODUCTS FOR AN APPLICATION INVOLVING SERIOUS RISK TO LIFE OR PROPERTY WITHOUT ENSURING THAT THE SYSTEM AS A WHOLE HAS BEEN DESIGNED TO ADDRESS THE RISKS, AND THAT THE OMRON PRODUCTS ARE PROPERLY RATED AND INSTALLED FOR THE INTENDED USE WITHIN THE OVERALL EQUIPMENT OR SYSTEM.

Disclaimers

PERFORMANCE DATA

Performance data given in this catalog is provided as a guide for the user in determining suitability and does not constitute a warranty. It may represent the result of OMRON's test conditions, and the users must correlate it to actual application requirements. Actual performance is subject to the OMRON *Warranty and Limitations of Liability*.

CHANGE IN SPECIFICATIONS

Product specifications and accessories may be changed at any time based on improvements and other reasons. Consult with your OMRON representative at any time to confirm actual specifications of purchased product.

DIMENSIONS AND WEIGHTS

Dimensions and weights are nominal and are not to be used for manufacturing purposes, even when tolerances are shown.

ALL DIMENSIONS SHOWN ARE IN MILLIMETERS.

To convert millimeters into inches, multiply by 0.03937. To convert grams into ounces, multiply by 0.03527.